

**ENG**

Translation of the  
original user guide



## PELENC POWER TOOLS BATTERY 750

**Operating instructions**

56\_145276-B  
09/2019

**READ THE USER GUIDE CAREFULLY BEFORE USE**

   #LOVEELECTRIC

**PELENC**



# TABLE OF CONTENTS

<b>1. INTRODUCTION .....</b>	<b>5</b>
<b>2. SAFETY .....</b>	<b>6</b>
2.1. SAFETY MEASURES ASSOCIATED WITH THE USE OF THE TOOL .....	6
2.2. SAFETY MEASURES ASSOCIATED WITH BATTERY USE .....	6
2.3. SAFETY MEASURES WHEN USING THE "PELENC" CHARGER .....	7
2.4. SAFETY SIGNAGE .....	8
<b>3. DESCRIPTION AND TECHNICAL CHARACTERISTICS .....</b>	<b>9</b>
3.1. TECHNICAL CHARACTERISTICS - BATTERY .....	9
3.2. TECHNICAL CHARACTERISTICS - CHARGER .....	9
3.3. DESCRIPTION .....	9
<b>4. COMMISSIONING .....</b>	<b>11</b>
4.1. CHARGING THE BATTERY .....	11
4.2. HMI DISPLAY .....	13
4.3. BATTERY ORIENTATION .....	14
4.4. NIGHT-TIME SIGNALISATION MODE .....	14
<b>5. USING THE TOOL .....</b>	<b>15</b>
5.1. CHOICE OF MENU .....	15
5.2. SELECTION OF THE TOOL NUMBER .....	16
5.3. USEFUL LIFE .....	17
<b>6. SERVICE .....</b>	<b>18</b>
6.1. MAINTENANCE .....	18
6.2. STATISTICS .....	19
6.3. MISC. MAINTENANCE .....	20
6.3.1. MISCELLANEOUS MAINTENANCE BATTERY .....	20
6.3.2. MISCELLANEOUS MAINTENANCE CHARGER .....	20
<b>7. INCIDENTS AND TROUBLESHOOTING .....</b>	<b>21</b>
7.1. SUMMARY OF HMI DISPLAY AND BEEP MESSAGES .....	21
7.2. BATTERY REPLACEMENT .....	22
<b>8. STORAGE AND TRANSPORT .....</b>	<b>23</b>
8.1. BATTERY STORAGE CONDITIONS .....	23
<b>9. ACCESSORIES AND CONSUMABLES .....</b>	<b>24</b>
9.1. TABLE OF THE LIST OF ACCESSORIES AND CONSUMABLES .....	24

**10. WARRANTIES ..... 25**

**10.1. GENERAL WARRANTIES ..... 25**

10.1.1. STATUTORY WARRANTY ..... 25

10.1.2. COMMERCIAL WARRANTYPELLENC ..... 25

10.1.3. PAID AFTER-SALES SERVICE ..... 26

**11. COMPLIANCE STATEMENTS ..... 28**

**11.1. "EC" DECLARATION OF CONFORMITY: 750 BATTERY ..... 28**

## 1. INTRODUCTION

Dear Customer,

Thank you for purchasing your Pellenc power tools battery 750. Correctly used and maintained, this tool will give a satisfactory performance for many years.



### **Warning**

Your device contains numerous recoverable or recyclable materials. Return it to your dealer or, failing this, to an approved servicing centre to be treated.



Comply with the regulations in force in your country as concerns environmental protection associated with your activity.



### **Warning**

It is imperative that you read through the ENTIRE user's manual before using or servicing the tool. Always comply with the instructions and illustrations in the manual.

All through this user guide you will find advisory notes and information entitled: NOTE, IMPORTANT, ATTENTION and WARNING.

The points marked "NOTE" indicate additional information.

The points marked "IMPORTANT" warn the user of a potential risk to the equipment.

The points marked "ATTENTION" warn the user of a potentially hazardous situation which if not avoided leads to minor injuries.

The points marked "WARNING" warn the user of a potentially hazardous situation which if not avoided leads to serious injury or death.

The warning  indicates that damage resulting from failure to comply with the procedures and instructions is not covered by the warranty and the owner will be liable for any repair costs.

Safety indications are also given on the tool; they remind you of the safety precautions to be taken. Identify and read these indications before using the tool. Immediately replace any indications that may become partially illegible or deteriorated.

Refer to Section 2.4, "Safety signage" for the location diagram of the safety stickers affixed to the tool.

No part of this manual may be reproduced without the written permission of the company PELLENC. The illustrations given in this manual are for information purposes and are in no way contractual. The PELLENC company reserves the right to make any modification or improvement to its products as deemed necessary without informing customers already in possession of a similar model. This manual forms an integral part of the tool and must accompany the tool if it changes hands.

## 2. SAFETY



### **Warning**

Never carry out maintenance work on damaged battery packs. Service of battery packs should only be performed by the manufacturer or authorized service providers.

### 2.1. SAFETY MEASURES ASSOCIATED WITH THE USE OF THE TOOL

#### **Note**

Please refer to the instructions of the tool concerned.



### **Warning**

Read all the safety measures and all the instructions. Retain all the safety measures and instructions for later reference.

This device is not intended for use by individuals (including children) with reduced physical, sensory or mental capabilities, nor by anyone lacking in experience or knowledge, except if they are supervised or have received prior instructions from a person responsible for their safety.

### 2.2. SAFETY MEASURES ASSOCIATED WITH BATTERY USE

1. If not using the battery unit, store it away from other metal objects such as paper clips, coins, keys, nails, screws or other such small metal items that might form a connection between the two terminals. Creating a short-circuit between the battery terminals can lead to burns or cause a fire.
2. Keep the battery out of the reach of children and place it on a non-combustible support.
3. Do not interfere with its cooling cycle.
4. Do not use or leave the battery near a heat source (> 60°C).
5. Do not leave the battery in direct, strong sunlight.
6. Do not expose the battery to microwaves or high pressure.
7. Do not immerse the battery in water.
8. The batteries must be charged in a dry, ventilated room at a temperature between 10°C and 25°C maximum, away from any moisture.
9. If the battery is not used for 10 days, the battery will automatically discharge until it reaches its storage charge rate, and then goes to sleep. It will heat up during this phase.
10. Over time, the capacity of your battery reduces. When it reaches half of its original battery-life operating time, it should be replaced.
11. The battery may lose 1 to 4 % of its capacity when exposed to a temperature higher than or equal to 55 °C for one week.
12. The charging location must be equipped with a class D fire extinguisher (for metal fires) in good working order.
13. The standards in effect must be complied with when either shipping a complete tool or a battery.
  - A complete tool with a battery is a product that is classified as class 9, UN3481.
  - Battery alone: product that is classified as class 9, UN3480.
14. Use of a battery other than that provided by Pellenc SA is dangerous (risk of serious injury). If a different battery is used, Pellenc SA cannot be held responsible for any consequences.
15. The battery must be protected from any impact and must be positioned and secured appropriately during transportation.
16. In the case of suspicious smoke, place the battery outside the charging area or transportation vehicle as far away as possible from any inflammable material.
17. Never store a battery when its capacity is below 50 %. Recharge the battery before storage if the value is below 50%.







18. In inappropriate conditions, a liquid can flow batteries; avoid contact with it. In the event of accidental contact, rinse with water. In the event of contact with eyes, seek professional medical help. The liquid leaking from the batteries can cause irritations or burns.
19. Pellenc power tools must only be used with the battery units designed for the purpose. Use of other battery units can present a risk of injury and fire.
20. Only recharge using the charger indicated by the manufacturer. A charger adapted to one type of battery unit may present a fire risk if used with a different battery unit.
21. Do not use the battery for any purpose other than that initially envisaged (exclusively for use with Pellenc tools).
22. At the end of its life, the battery must be returned to the authorized distributor from whom it was purchased to be recycled in accordance with waste regulations.
23. Fragile case, contains an electronic board and lithium.

### 2.3. SAFETY MEASURES WHEN USING THE "PELENC" CHARGER

1. When in operation, the charger's temperature can reach 60°C. No flammable material must be within 1.5 metres of the charger and battery.
2. Place the charger out of children's reach and onto a non-combustible support.
3. Do not interfere with its cooling cycle.
4. The charger supplied with the battery is designed to recharge the battery. Do not charge non-rechargeable batteries.
5. The charging location must be equipped with a class D fire extinguisher (for metal fires) in good working order.
6. If the output cord is cut or damaged, bring the entire charger back to the authorised distributor where the tool was purchased.
7. Only recharge using the "PELENC" charger indicated by the manufacturer. A charger adapted to one type of battery unit may present a fire risk if used with a different battery unit.
8. This charger is designed to charge the batteries of Pellenc's lithium tools.
9. Do not use it for any other purposes.
10. Children must be supervised to ensure they do not play with the charger.
11. Verify that the cable cannot be folded and does not touch hot surfaces or sharp edges.
12. Ensure good ventilation during the charge.
13. Never cover the charger. This charger must not be used outdoors.
14. Make sure the power connector is not exposed to water.
15. Never charge a damaged battery.
16. The grid connection must comply with national electrical regulations.
17. Check the cable of the charger before using it. Never use the charger if the cable is damaged
18. When the battery is charging, place the charger on a non-flammable support, more than 1.5 m away from any flammable object.

**2.4. SAFETY SIGNAGE**

750 battery

<p><b>BATTERY Li-Ion</b> <b>REFERENCE 145237</b> <b>ULIB 750</b></p>	<p><b>43.2V x 17.25Ah = 745Wh</b> <b>IEC/EN 61960</b> <b>43.2V 16.5Ah</b> <b>12INR19/66-5</b></p>	     
<p>A utiliser uniquement avec le chargeur batterie PELENC modèle Usar sólo con el cargador de batería PELENC del modelo For use only with PELENC's battery charger model Nur zur Verwendung mit dem Ladegerät Modell PELENC Só usar com o carregador de batería PELENC Per l'utilizzo solo con il caricabatteria modello PELENC</p>		<p>- CB5022 - CB5022HV</p> 



Protection rating IP54 (Allover protection against dust and water spray).



Read the user guide.



This equipment must be used at a temperature of between -5° and +35°C.



Lithium-ion battery.

At the end of its life, the battery must be returned to the authorized distributor from whom it was purchased to be recycled in accordance with waste regulations.



Tool compliant with Moroccan standards.



Tool compliant with EC standards.



Marking symbol for identifying the chemical characteristic of the battery during recycling.



### 3. DESCRIPTION AND TECHNICAL CHARACTERISTICS

#### 3.1. TECHNICAL CHARACTERISTICS - BATTERY

Characteristics of 750 battery	
Rated battery voltage	43.2 V <sup>nom</sup>
Type of battery	12 times 5 elements included in 1 pack
Battery capacity	17.25 Ah
Battery power	745 Wh
Battery-life	Depending on the tool
Weight of the battery	4.5 kg
Weight of the carrying vest (comfort harness)	1.5 kg
Weight of the carrying vest (light harness)	0.83 kg
Operating frequency bands	13.56 MHz, receiver

#### 3.2. TECHNICAL CHARACTERISTICS - CHARGER

	CB5022 Charger	CB5022HV charger
Commercial reference of the charger	57230	57256
Tension	100-240V ~ 50/60Hz 140W class II	100-240V ~ 50/60Hz 130W class I
Charging voltage	50.2 V dc	
Charging current	2.2A dc max.	

Type of charger	Charge level 750 battery	750 battery charging time
CB5022 Charger	90 %	7.30 a.m.
	100%	9 hrs
CB5022HV charger	90 %	7.30 a.m.
	100%	9 hrs

#### 3.3. DESCRIPTION

##### Battery

1. Picker power connector
2. Button for locking/unlocking the battery on its support
3. Charge connector cap
4. Charging connector
5. Reflective surfaces
6. Push button ON/OFF down
7. Push button ON/OFF up
8. Safety stop for light harnesses

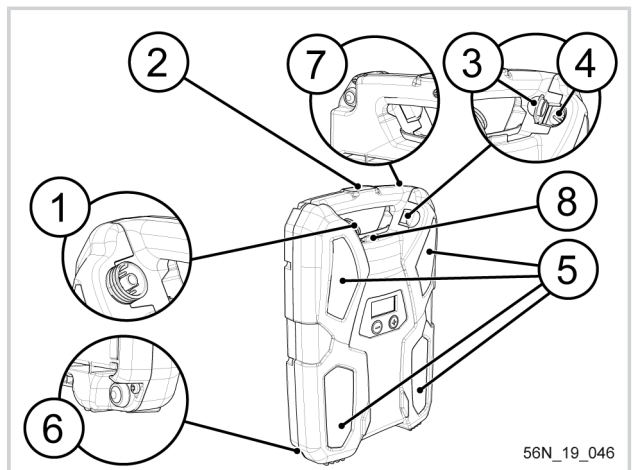

56N\_19\_046

**HMI (Human-Machine Interface)**

- 9. HMI navigation buttons
- 10. Consumption statistics menu
- 11. Maintenance menu
- 12. Time counter menu
- 13. Defect indicator
- 14. 3-Character display
- 15. Power supply indicator
- 16. Charging level
- 17. 8-Character display

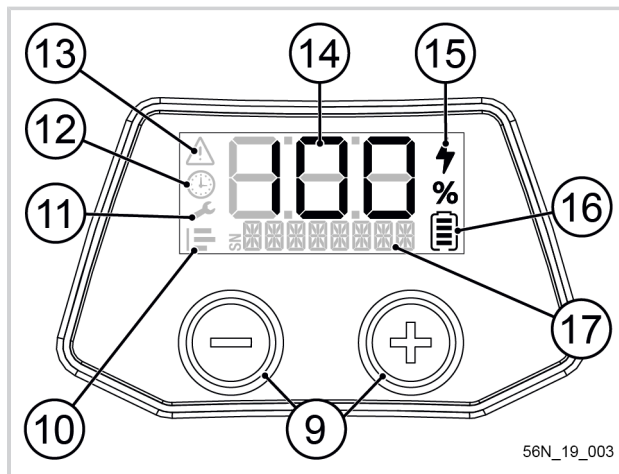

**Charger**

- 18. Charging connector
- 19. Indicator light
- 20. Power cord

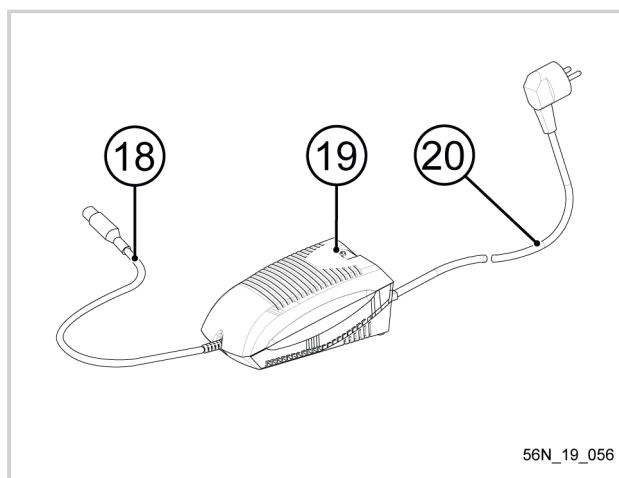

## 4. COMMISSIONING

### 4.1. CHARGING THE BATTERY

#### **Important**

The battery must be fully charged (100 %) before being using for the first time in the new season.

When the battery is discharged, the tool stops automatically. The display (14) indicates 0% and the buzzer beeps intermittently (see Section 7.1, “Summary of HMI display and beep messages”).

1. Disconnect the tool
2. Press one of the push buttons (6 or 7) to turn off the battery. When the battery is turned off, the power supply indicator (15) disappears.

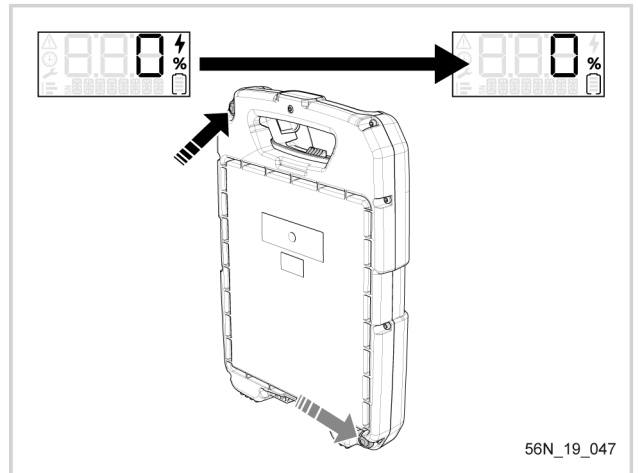

3. Place the charger and battery in a dry, ventilated and dust-free room at 10#25°C. Place the battery in a stable, horizontal or vertical position.

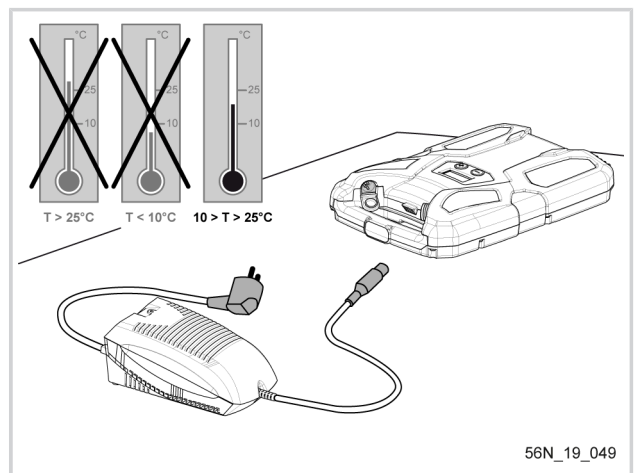

4. Connect the charger power connector (20) to the electrical power outlet.

#### **Warning**



Ⓒ Before connecting the charger to the mains, check that your power system characteristics comply with the specifications given on the charger (see Section 3.1, “Technical characteristics - Battery”).

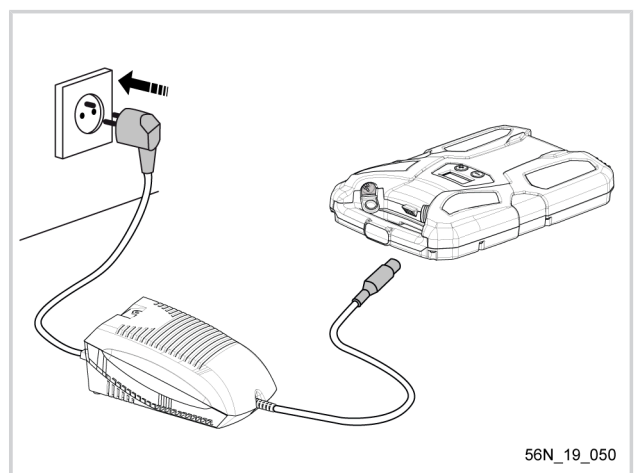

5. The charger LED (19) turns red.

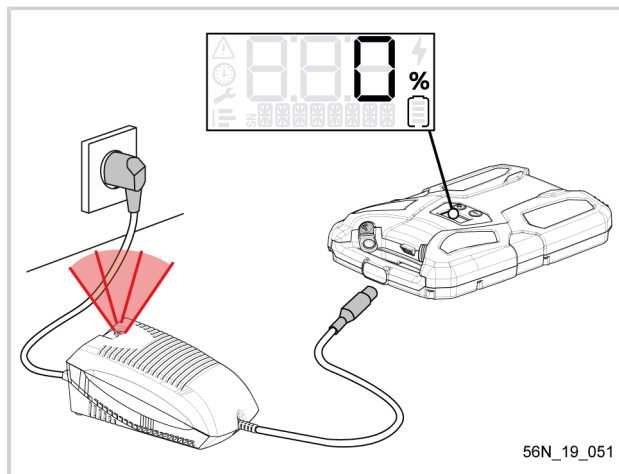

6. Connect the charging cord (18) to the battery's charging connector (4). The battery beeps twice when it recognizes the charger, the charger light turns green blinking green after a few seconds

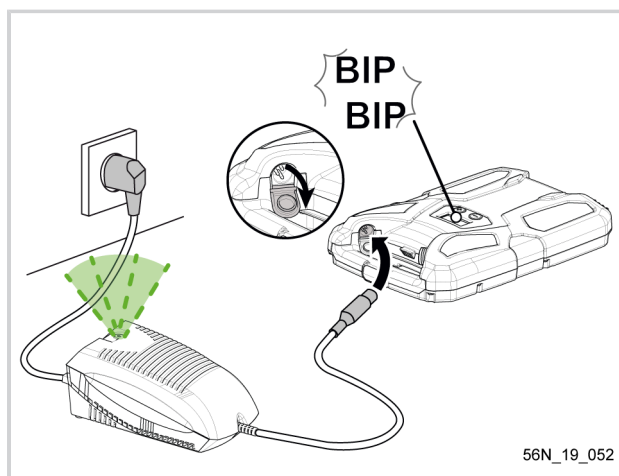

7. The battery is charging: The charger LED lights up green and flashes. The segments of the charging indicator flash in sequence.

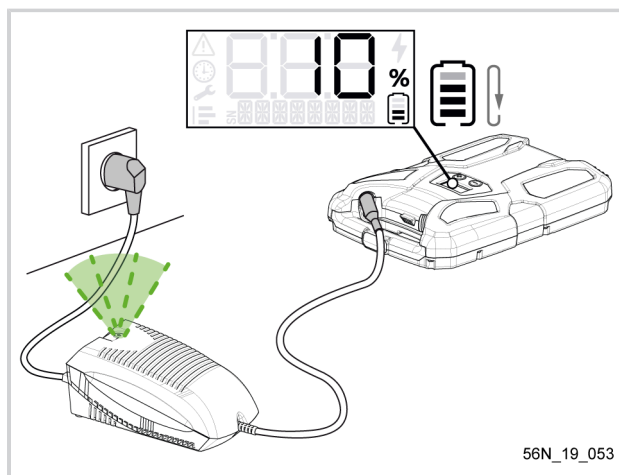

- Charging is complete when the message 100% appears on the display. The charger LED lights up green and is static. All segments are flashing on the indicator.

**Note**

If the segments continue to flash in sequence despite 100% being displayed, then charging is not yet complete.

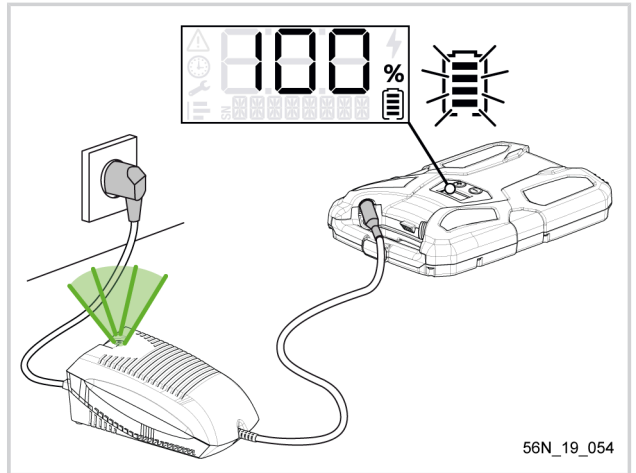

- Once the battery is charged, disconnect the charging lead on the battery first, then the charger power connector.

**Note**

After a long storage period (new battery, winter storage, etc.), when you disconnect the charger, the HMI display may indicate a value inferior to 100%. This is a normal phenomenon which can re-occur for up to 5 charge cycles with normal use between each charge.

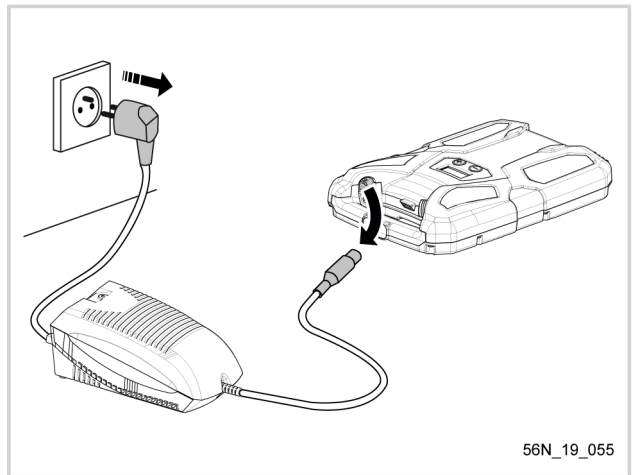

**4.2. HMI DISPLAY**

The battery has a HMI display showing the remaining capacity. The capacity is expressed as a percentage.

- If the display shows 100%, the battery is fully charged.
- If after a day's work the display shows 55%, there is no need to recharge the battery before another day of similar work.
- If the display shows 00, or very close to it, it must be recharged at once.
- The battery gauge should be used like the fuel gauge on a car.
- When the tool is being used the line on the bottom of the screen indicates the power consumed.

The + and - buttons on the battery are used for navigating in the HMI

- Press on - for 1 second to open the MENU.
- Press on - once to select the following MENU.
- Press on + once to validate the choice and open the MENU.

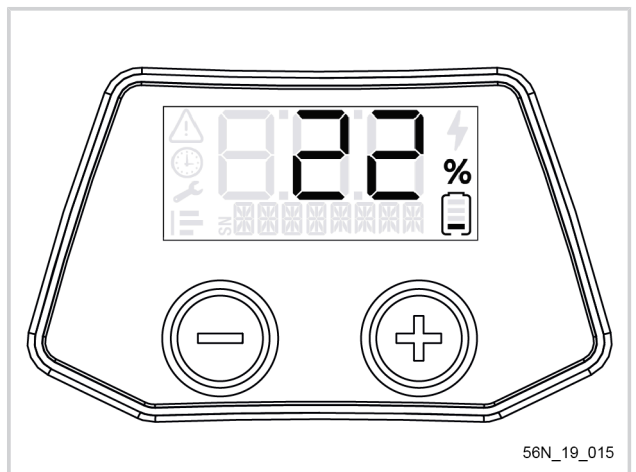

### 4.3. BATTERY ORIENTATION

The HMI display automatically orients itself based on the position of the battery. The push-button is also accessible at the bottom on the right because it is located in both positions.

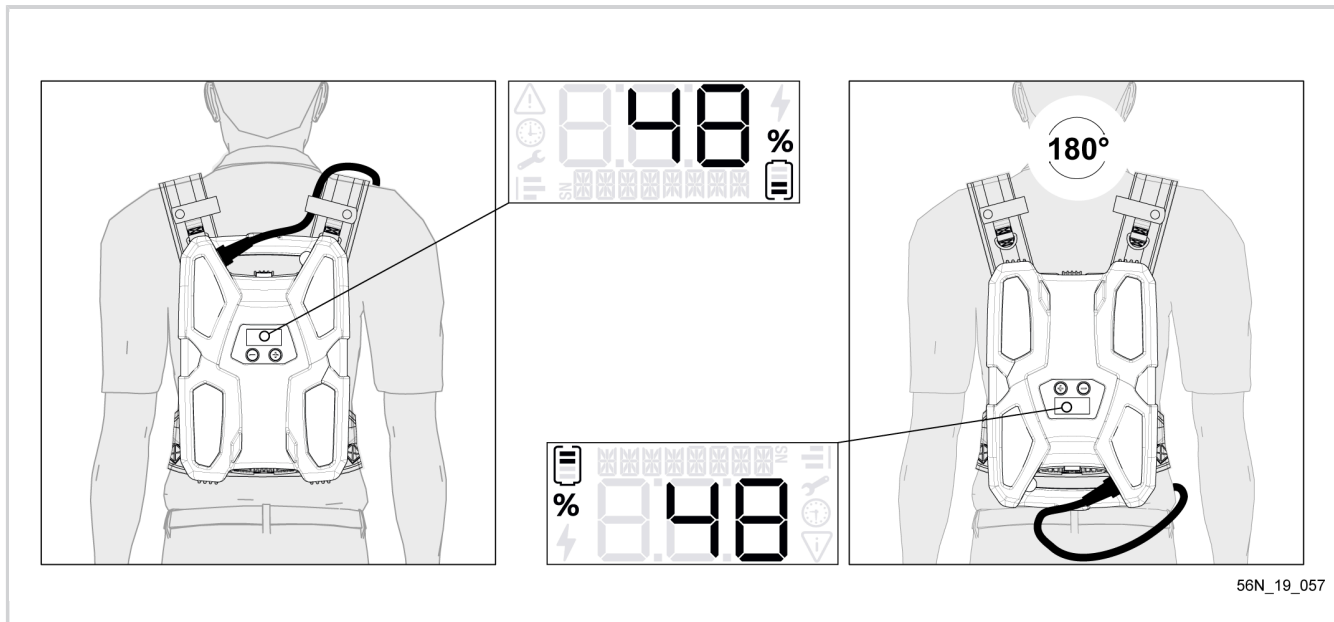

### 4.4. NIGHT-TIME SIGNALISATION MODE

The HMI display switches to night mode by simultaneously pressing the "-" and "+" buttons for 1 second.

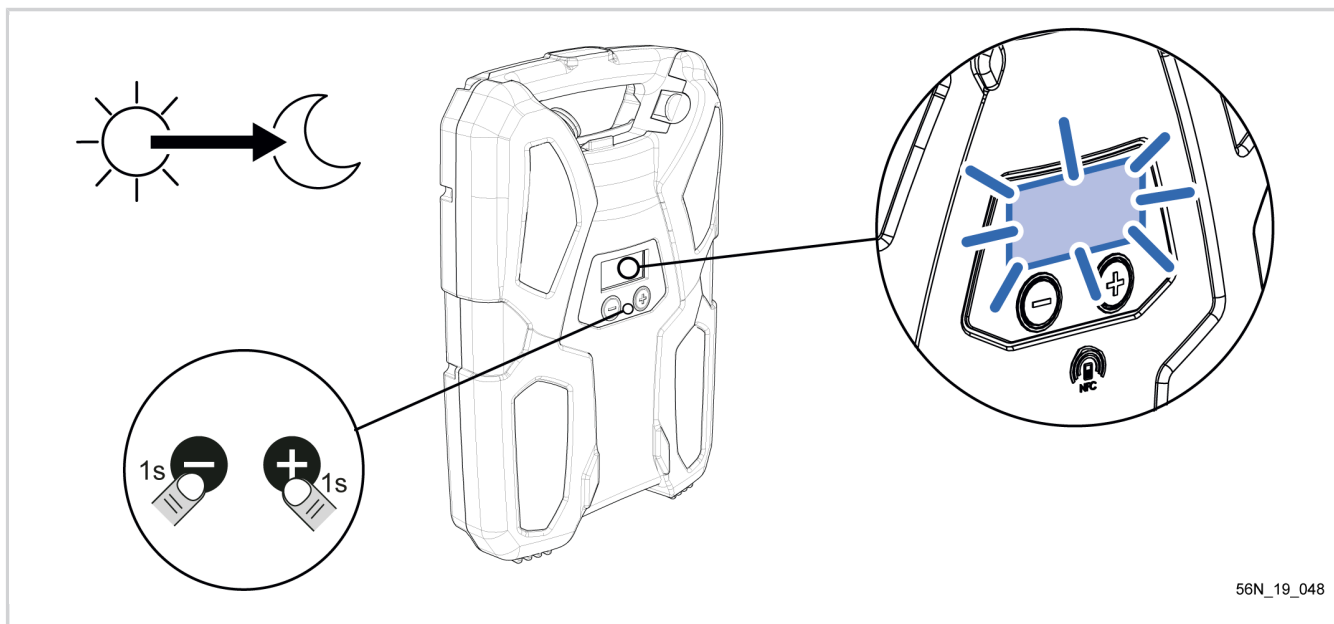

**5. USING THE TOOL**

**5.1. CHOICE OF MENU**

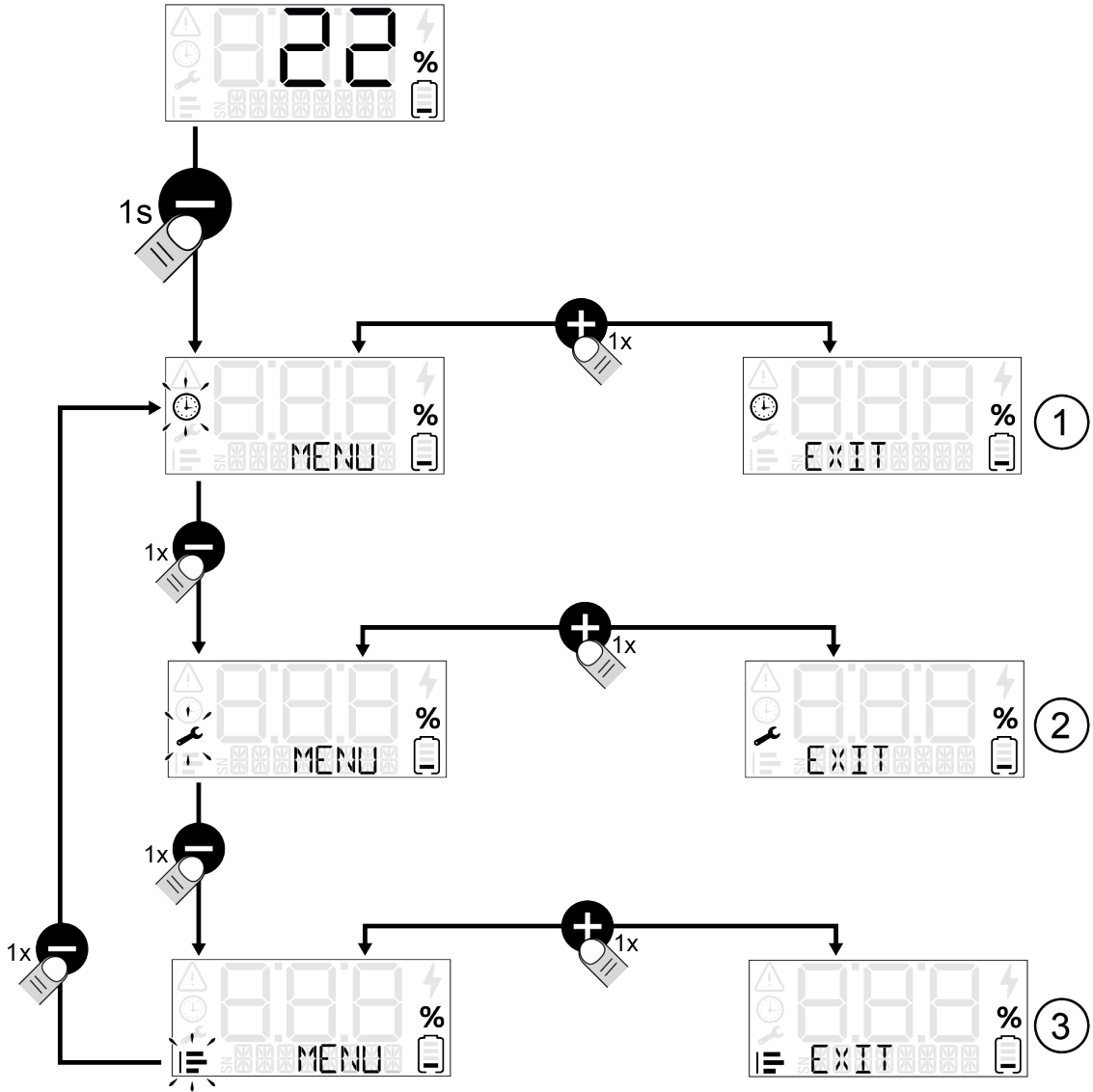

56N\_19\_058

Reference number illustration	Menu type
1	Operating time menu, refer to Section 5.3, "Useful life"
2	Maintenance menu, refer to Section 6.1, "Maintenance"
3	Statistics menu, refer to Section 6.2, "Statistics"

**5.2. SELECTION OF THE TOOL NUMBER**

It is possible to see the data corresponding to each tool connected to the battery in each of the "TOOL" tools menus. For this, once you are in the menu (shown as \* in the illustrations), select the number (from 1 to 30) corresponding to the type of tool you want to have information about using the (+) button.

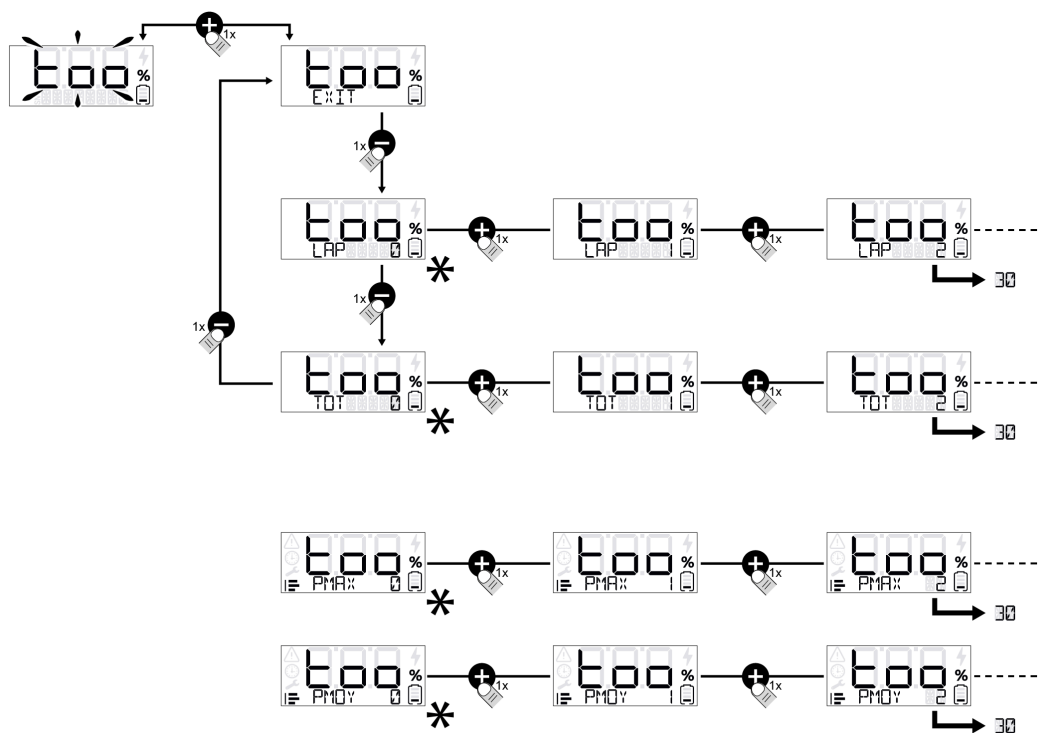

56N\_19\_017

**Table of correspondences**

TOOL	NUMBER
Olivion	1
Lixion adaptable	2
Treelion adaptable	3
Helion	4
Excelion	5
Airion	6
Rasion	7
Cultivion	8
Selion	9
Tool 10	10
Tool 11	11
Tool 12	12
Sweeper	13
Tool 14	14
Tool 15	15

TOOL	NUMBER
Tool 16	16
Tool 17	17
Tool 18	18
Tool 19	19
Tool 20	20
Tool 21	21
Tool 22	22
Tool 23	23
Tool 24	24
Tool 25	25
Tool 26	26
Tool 27	27
Tool 28	28
Tool 29	29
Tool 30	30



**5.3. USEFUL LIFE**

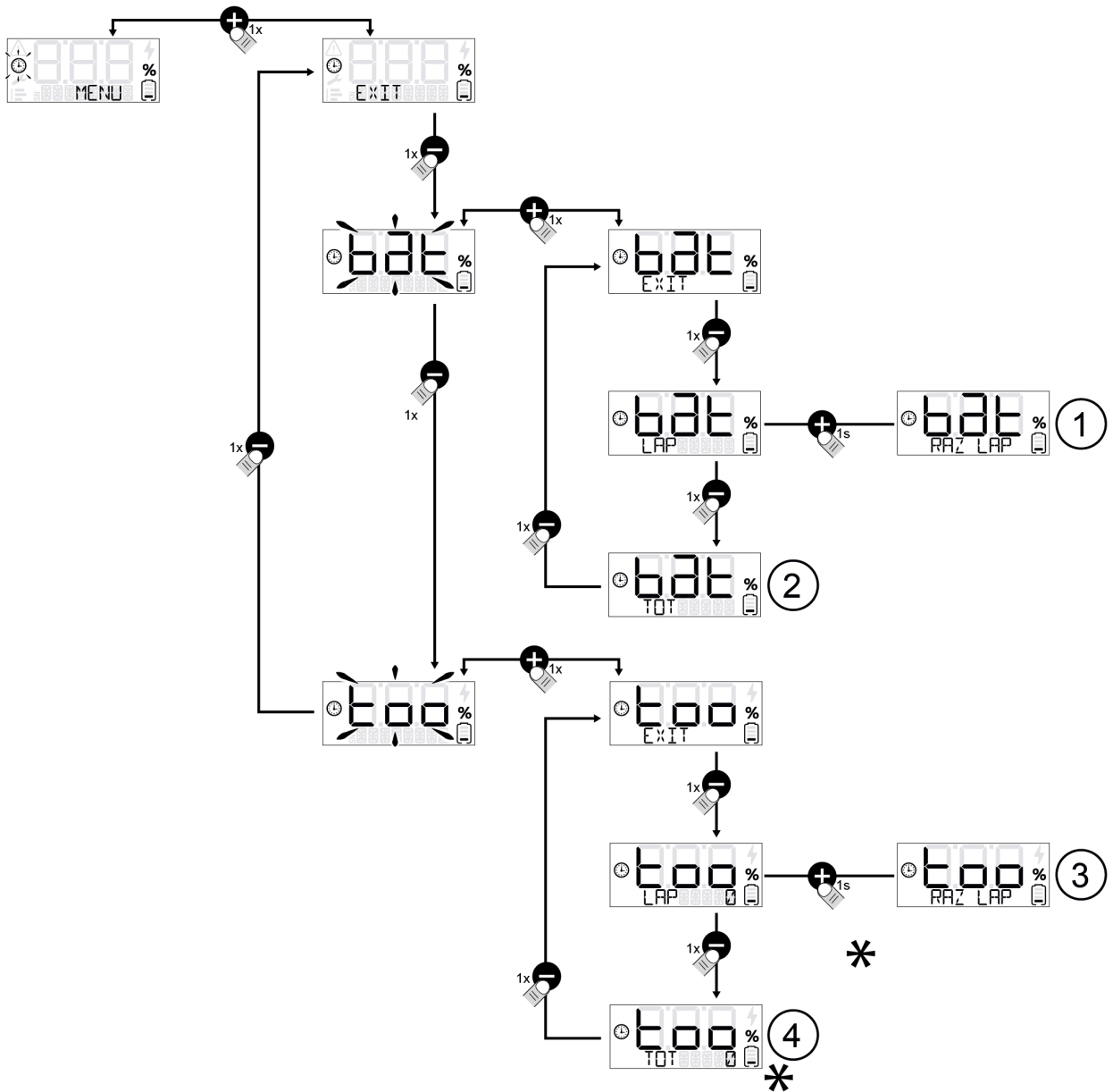

56N\_19\_018

Reference number illustration	Duration of use menu
1	Partial useful life of the battery with the possibility of a reset (RTZ)
2	Total useful life of the battery
3	Partial useful life of each tool family on the battery with the possibility of a reset (RTZ)
4	Total useful life of each tool family on the battery

**6. SERVICE**

**6.1. MAINTENANCE**

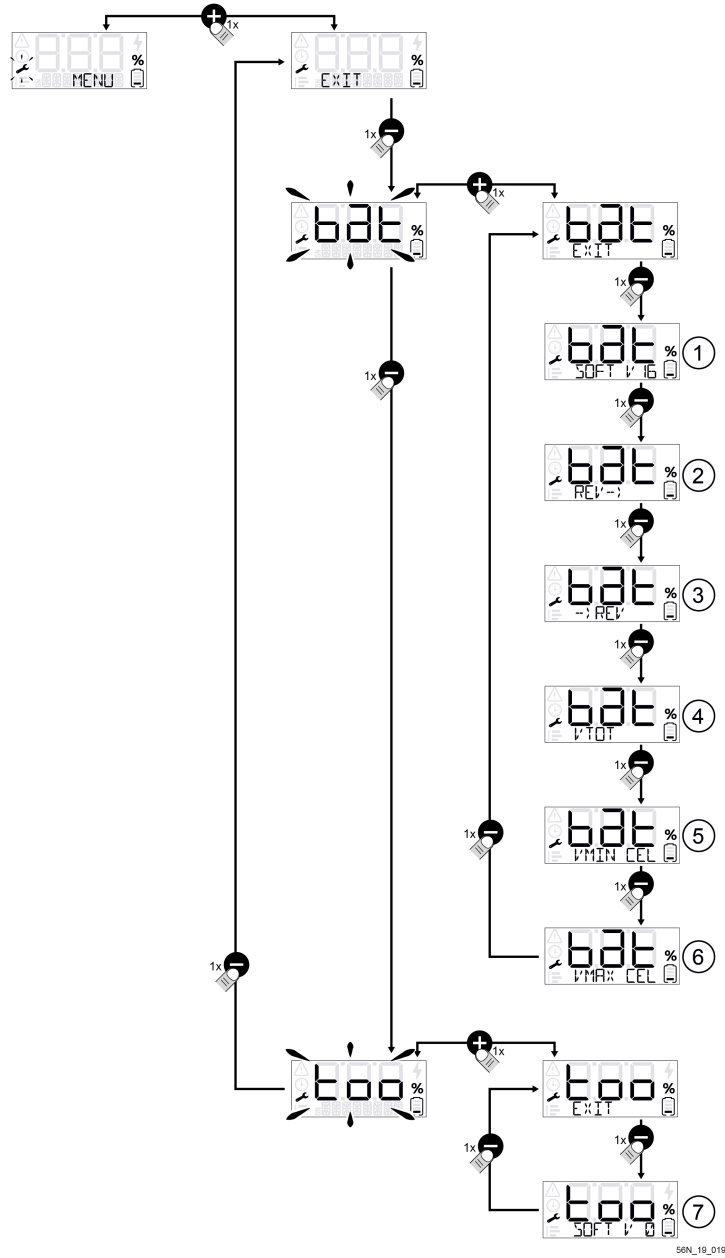

56N\_19\_019

Reference number illustration	Maintenance menu
1	Battery software version.
2	Time in use since last revision
3	Time in use till next revision
4	Total voltage of the battery
5	Min. cell voltage
6	Max. cell voltage
7	Software version of the last tool used

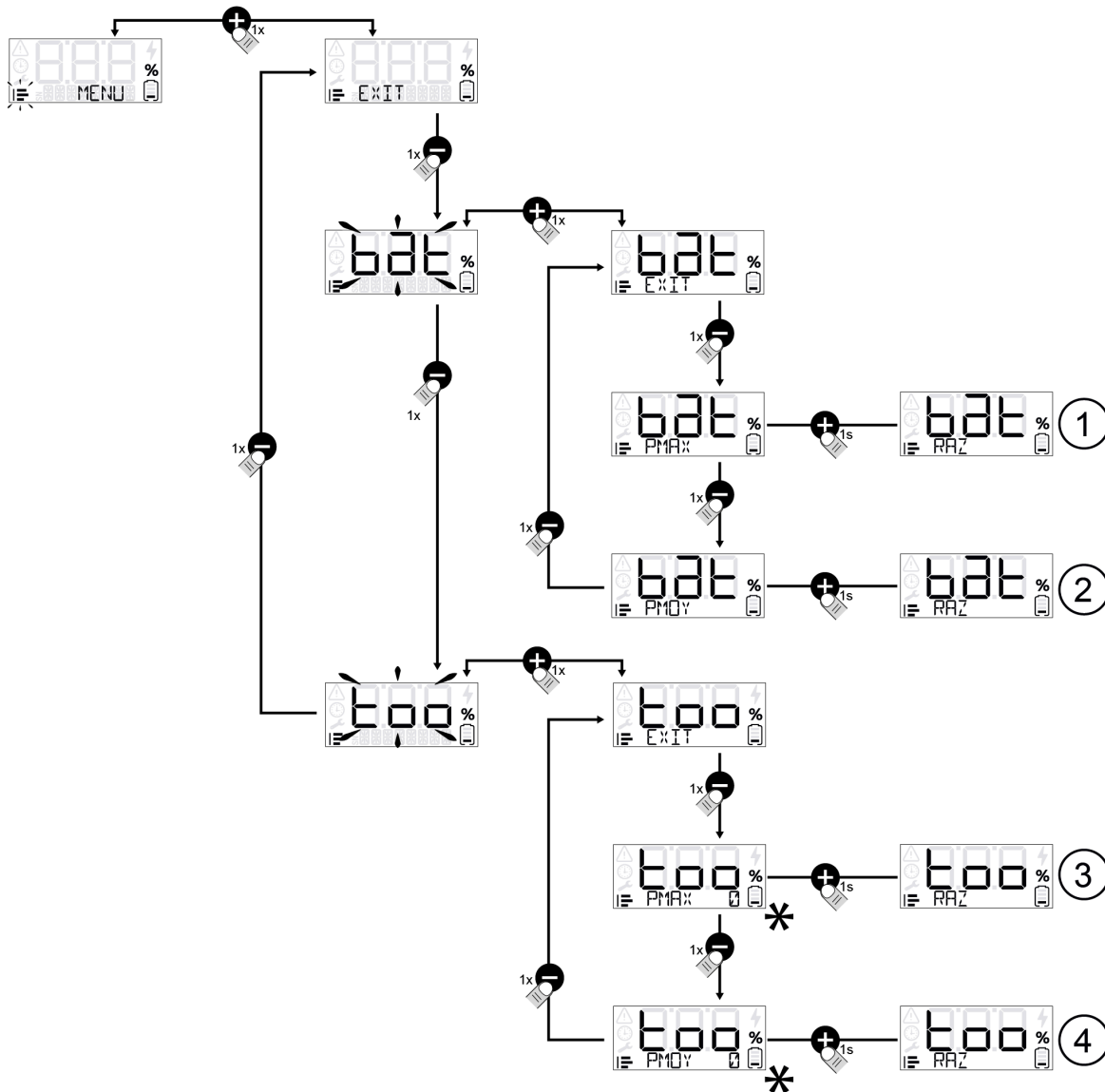
**6.2. STATISTICS**

56N\_19\_020

Reference number illustration	Statistics menu
1	Max. power generated by the battery (RTZ)
2	Average power over the useful life of the battery (RTZ)
3	Max. power requested by a tool family on the battery (RTZ)
4	Average power requested by a tool family on the battery (RTZ)

**Note**

To perform a reset (RAZ) press and hold +. To immediately return to the main screen briefly press on + and - simultaneously.

### 6.3. MISC. MAINTENANCE

#### 6.3.1. MISCELLANEOUS MAINTENANCE BATTERY







The battery must not be connected to the charger or the tool, the switch must be in the off position. Disconnect the battery before cleaning. Disconnect the battery before cleaning. Clean the battery casing with a soft cloth and water.



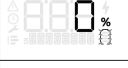

#### 6.3.2. MISCELLANEOUS MAINTENANCE CHARGER



Disconnect the charger before cleaning it. Clean the charger casing with a soft cloth and water.

## 7. INCIDENTS AND TROUBLESHOOTING

### 7.1. SUMMARY OF HMI DISPLAY AND BEEP MESSAGES

Normal messages		
<b>Using the tool</b>		
		Battery capacity (0 to 100%) The segments of the battery indicate the battery charge level.
	With 1 beep per minute	Battery empty, recharge immediately
	flashing with 1 beep every 10 seconds	Stop using, recharge immediately
<b>Charging</b>		
	The cells of the battery scroll.	The battery is charging, battery capacity (0 to 100%)
	The cells of the battery flash.	Charging complete
<b>Storage</b>		
		BALANCE is displayed during discharge before storage.
		Once the storage level is reached, the battery goes into stand-by. The indicator displays STOCK when awakened on the storage level.

Degraded mode messages		
<b>Using the tool</b>		
		Stop the tool; the battery temperature is too high
		Stop the tool; the battery temperature is too low
		Stop the tool; the battery board temperature is too high
	Long beep and 1 short beep	Stop the tool: intensity is too high
	Long beep and 4 short beeps	Stop the tool; the tool temperature is too high
<b>Charging</b>		
		Charge interrupted: Battery temperature too low
		Charge interrupted: Battery temperature too high

Fault messages		
<b>Using the tool</b>		
	Beep every 2 minutes for 24 hours	Voltage too low after 3 hours of non-use. Recharge battery immediately
<b>Charging</b>		
	Continuous beep	Battery problem
		Charger problem

**Note**

Message DEF TOOL + number: Signals a tool defect. When an tool error message appears on the battery, the tool stops until the defect is resolved. To find out what the defect is refer to the tool instructions or contact your authorized distributor. To acknowledge the error message of the battery screen: Press and hold the (+) sign

**If your tool no longer works:**

1. Make sure to turn off the battery using one of the two on/off switches.
2. Check the battery is charged, as shown on the gauge.
3. Check the lead is connected and the cable thumb-wheel tightened.
4. Press on one of the two on/off switches. Press the trigger and the safety lock (depending on the tool).
5. If the tool does not work, return the complete equipment in its original packaging to a certified repair service.

**Warning**

Ⓒ Never attempt to open one or more elements of the "battery" or the charger unit (you risk damaging them and most importantly, you void the warranty).

**7.2. BATTERY REPLACEMENT****Important**

The battery must be replaced only by an approved distributor.

## 8. STORAGE AND TRANSPORT

### 8.1. BATTERY STORAGE CONDITIONS

- Store the “battery” unit and charger away from heat, dust and humidity, after turning off the battery using one of the on/off. buttons Never store the battery in an ambient temperature of more than +45 °C.
- In order to conserve a long battery life and prevent deterioration, the battery must be charged when stored and recharged every 24 months if it is not used.
- Never operate the push-buttons during the storage period.
- To ensure long battery life, the battery should be stored in a dry and warm place between 0 °C and 25 °C.
- No combustible object must be placed within 1.5 metres of the battery.
- The charger is maintenance-free.
- If the battery is not used for 10 days, the battery will automatically discharge until it reaches its storage charge rate, then goes to standby. It will heat up during this phase.

## 9. ACCESSORIES AND CONSUMABLES

### 9.1. TABLE OF THE LIST OF ACCESSORIES AND CONSUMABLES

Spare parts / accessories	reference
CB5022 Charger	57230
CB5022HV charger	57256
Comfort harness	57183
Lightweight harness	57257
Quick connector adapter	57368
Old connector adapter	57239



## 10. WARRANTIES

### 10.1. GENERAL WARRANTIES

#### 10.1.1. STATUTORY WARRANTY

##### - 10.1.1.1. LATENT DEFECTS WARRANTY

Apart from the commercial warranty provided for under Article II, Article 1641 of the Civil Code provides that "the seller is bound to a warranty on account of latent defects of the object sold which render it unfit for the use for which it was intended, or which would impair said use to the extent that the buyer would not have acquired it, or would only have given a lesser price for it, had he known of them".

Article 1648 of the Civil Code "The action resulting from latent defects must be brought by the purchaser within two years after the discovery of the defect. "

##### - 10.1.1.2. LEGAL WARRANTY OF CONFORMITY

Article L.217-4 of the Consumer Code "The seller delivers goods in conformity with the contract and is liable for defects of conformity existing upon delivery.

The seller is also liable for any lack of compliance resulting from the packaging, assembly or installation instructions whenever its contractual liability is engaged in this regard or the latter are carried out under its responsibility

Article L.217-5 of the French Consumer Code "Goods are compliant with the contract":

1. Where they are fit for the purpose normally expected of similar goods and, where applicable:
  - If it matches the description given by the seller and possesses the qualities that were presented to the purchaser in the form of a sample or model;
  - If it possesses the qualities that a purchaser can reasonably expect given the public statements made by the seller, the producer or its representative, especially in advertising or labelling;
2. Or, if it has the characteristics defined by mutual agreement of the parties or is fit for any particular purpose that the buyer made known to the seller and that the latter accepted.

Article L.217-12 of the Consumer Code "legal action resulting from lack of conformity lapses two years after delivery of the goods".

#### 10.1.2. COMMERCIAL WARRANTYPELLENC

##### - 10.1.2.1. CONTENT

###### 10.1.2.1.1. GENERAL INFORMATION

In addition to legal warranties, client users benefit from the commercial warranty on products PELLENC covering the exchange and replacement of parts recognised as being out of order, due to machining defects, assembly defects or material defects, whatever the cause.

The warranty is fully integral to the product sold by PELLENC.

###### 10.1.2.1.2. SPARE PARTS

The commercial warranty also covers original PELLENC spare parts, excluding labour and to the exclusion of certain parts of each product provided at delivery.

**- 10.1.2.2. DURATION OF THE WARRANTY****10.1.2.2.1. GENERAL INFORMATION**

PELLENC Products are guaranteed under the commercial warranty as from delivery to the customer for a period of two (2) years for products connected to a PELLENC battery, and for a period of one (1) year for other PELLENC products.

**10.1.2.2.2. SPARE PARTS**

PELLENC Replacement parts replaced under the product warranty are guaranteed under the commercial warranty as from delivery of the PELLENC product to the customer user for a period of two (2) years for products connected to a PELLENC battery, and for a period of one (1) year for other PELLENC products.

In the case of products connected to a PELLENC battery, parts that are replaced under the product warranty after the 12th month of use, are covered for a period of one (1) year.

**10.1.2.2.3. WARRANTY EXCLUSIONS**

Excluded from the commercial warranty are products that have been subject to abnormal use, or were used under conditions and for purposes other than those for which they were manufactured, especially in the case of non-compliance with conditions stipulated in this user manual.

It does not apply in case of shock, fall, neglect, lack of supervision or maintenance or in case of transformation of the product. Also excluded from the warranty are products that have been subject to tampering, alteration or modification by the client user.

Wear parts and/or consumables cannot be covered by the warranty.

**- 10.1.2.3. IMPLEMENTATION OF THE COMMERCIAL WARRANTY****10.1.2.3.1. PRODUCT COMMISSIONING AND COMMISSIONING DECLARATION**

The DISTRIBUTOR undertakes to complete the computer commissioning declaration form, no later than eight days after the delivery of the property to the user customer, in order to activate the latter on the [www.pellenc.com](http://www.pellenc.com) website under "warranties and training" in the "extranet" menu, using the identifier previously provided to them by PELLENC.

Failing that, commissioning declaration will not be effective and implementation of the commercial warranty PELLENC will not occur. As a consequence thereof, the DISTRIBUTOR must ensure the financial burden of its intervention under the warranty without being able to pass on the cost to the client user.

The DISTRIBUTOR shall also undertake to complete the warranty card or the certificate of warranty and commissioning for self-propelled equipment provided with the product after having the client user sign and date it.

**10.1.3. PAID AFTER-SALES SERVICE****- 10.1.3.1. GENERAL INFORMATION**

Malfunctions, breakdowns, breakages resulting from misuse, neglect or improper maintenance by the client user as well as malfunctions resulting from normal wear of the product are subject to the payment of after-sales service, even during the period of the legal and commercial warranty. After-sales service repairs that fall outside of the legal and commercial warranty also include maintenance, adjustments, diagnostics of all types, and cleaning without the present list being exhaustive.

**- 10.1.3.2. WEAR PARTS AND CONSUMABLES**

Wear parts and consumables also fall within the after-sales service.

**- 10.1.3.3. SPARE PARTS**

Paid after-sales service also covers original PELENC spare parts, excluding labour and outside the legal and commercial warranty period.

In case of replacement of original PELENC spare parts in the context of after-sales service, said latter are covered by a warranty of one year as from the installation date.

**11. COMPLIANCE STATEMENTS**

**11.1. "EC" DECLARATION OF CONFORMITY: 750 BATTERY**

MANUFACTURER	PELLENC
ADDRESS	Quartier Notre-Dame - 84120 Pertuis (France)

ENTITY AUTHORIZED TO COMPILE THE TECHNICAL FILE	PELLENC
ADDRESS	Quartier Notre-Dame - 84120 Pertuis (France)

We hereby declare that the machine referred to below as:

GENERIC DENOMINATION	BATTERY
FUNCTION	Intended to power PELLENC portable power tools
COMMERCIAL NAME	ULTRA LITHIUM BATTERY
TYPE	Li-ion battery
MODEL	750
SERIAL No.	56U00001 - 56U49999 56V00001 - 56V49999 56W00001 - 56W49999

Complies with the relevant provisions of the battery directive 2006/66/EC

Complies with the provisions of the following European directives:

- 2014/30/EU EMC Directive
- 2011/65/EU ROHS Directive
- 1907/2006 REACH Regulation
- 2014/53/EU RED Directive

The following harmonised European standards have been used in whole or in part:

- EN 62133-2 : 2017

SIGNED IN PERTUIS, DATED 19/08/2020  
JEAN-MARC GIALIS  
CEO









# **PELLENC**

   [www.pellenc.com](http://www.pellenc.com)

PELLENC  
Quartier Notre Dame - 84120 Pertuis (France)

