

**ENG**

Translation of the original operating instructions manual



## PELLENC POWER TOOLS BATTERY 150

Operating instructions

56\_158889-A  
01/2022

**READ THE USER GUIDE CAREFULLY BEFORE USE**



# TABLE OF CONTENTS

<b>1. INTRODUCTION .....</b>	<b>5</b>
<b>2. SAFETY .....</b>	<b>6</b>
2.1. SAFETY MEASURES ASSOCIATED WITH THE USE OF THE TOOL .....	6
2.2. SAFETY MEASURES ASSOCIATED WITH BATTERY USE .....	6
2.3. SAFETY MEASURES WHEN USING THE "PELENC" CHARGER .....	7
2.4. SAFETY SIGNAGE .....	8
<b>3. DESCRIPTION AND TECHNICAL CHARACTERISTICS .....</b>	<b>9</b>
3.1. DESCRIPTION .....	9
3.2. BATTERY TECHNICAL FEATURES .....	9
3.3. TECHNICAL CHARACTERISTICS - CHARGER .....	9
<b>4. COMMISSIONING .....</b>	<b>11</b>
4.1. SWITCHING THE BATTERY ON AND OFF .....	11
4.2. HMI DISPLAY .....	11
4.3. CHARGING .....	11
4.4. FITTING THE HOLSTER TO THE BELT .....	13
4.5. TOOL CONNECTION .....	13
4.6. PUTTING THE LEAD AND WRIST STRAP IN PLACE .....	14
<b>5. USING THE TOOL .....</b>	<b>15</b>
5.1. AUTHORISATION MODES .....	15
5.1.1. CHANGE OF AUTHORISATION MODE .....	15
5.1.2. PRESENTATION OF AUTHORISATION MODES .....	15
<b>6. MAINTENANCE .....</b>	<b>16</b>
6.1. MAINTENANCE TABLE .....	16
6.2. CLEANING THE BATTERY .....	16
6.3. CLEANING THE CHARGER .....	16
<b>7. INCIDENTS AND TROUBLESHOOTING .....</b>	<b>18</b>
7.1. RECAP OF BATTERY DISPLAY MESSAGES AND AUDIBLE SIGNALS .....	18
7.2. TROUBLESHOOTING .....	19
7.3. BATTERY REPLACEMENT .....	20
<b>8. STORAGE AND TRANSPORT .....</b>	<b>21</b>
8.1. BATTERY STORAGE CONDITIONS .....	21
<b>9. ACCESSORIES AND CONSUMABLES .....</b>	<b>21</b>
9.1. OPTIONAL ACCESSORIES .....	21

<b>9.2. CONSUMABLES .....</b>	<b>22</b>
<b>10. WARRANTIES .....</b>	
<b>10.1. GENERAL WARRANTIES .....</b>	<b>23</b>
10.1.1. STATUTORY WARRANTY .....	23
10.1.2. COMMERCIAL WARRANTYPELENC .....	23
10.1.3. PAID AFTER-SALES SERVICE .....	24
<b>11. COMPLIANCE STATEMENTS .....</b>	
<b>11.1. "EU" DECLARATION OF CONFORMITY: 150 BATTERY .....</b>	<b>26</b>
<b>11.2. UK DECLARATION OF CONFORMITY <sup>UK</sup><sub>CA</sub> : BATTERIE 150 .....</b>	<b>27</b>
<b>11.3. "EU" DECLARATION OF CONFORMITY: CHARGER CB5010HV .....</b>	<b>28</b>
<b>11.4. UK DECLARATION OF CONFORMITY <sup>UK</sup><sub>CA</sub> : CB5010HV CHARGER .....</b>	<b>29</b>
<b>11.5. "EU" DECLARATION OF CONFORMITY: CHARGER CB5004HV2 .....</b>	<b>30</b>
<b>11.6. UK DECLARATION OF CONFORMITY <sup>UK</sup><sub>CA</sub> : CHARGEUR CB5004HV/5004HV2 .....</b>	<b>31</b>

## 1. INTRODUCTION

Dear Customer,

Thank you for purchasing your Pellenc power tools battery 150. Properly used and maintained, this equipment will give you years of satisfaction.



### Warning

Your machine contains numerous recoverable or recyclable materials. Return it to your dealer or, failing this, to an approved servicing centre to be treated.



Comply with the regulations in force in your country as concerns environmental protection associated with your activity.



### Warning

It is imperative that you read through the ENTIRE user's manual guide before using or servicing the tool. Always comply with the instructions and illustrations provided in the user's manual.

Throughout the user's manual guide you will find advisory notes and information entitled: NOTE, IMPORTANT, ATTENTION and WARNING.

Points marked "NOTE" indicate additional information.

Points marked "IMPORTANT" warn the user of a potential risk for the equipment.

Points marked "ATTENTION" warn the user of a potentially hazardous situations which if not avoided may result in minor injuries.

Points marked "WARNING" warn the user of a potentially hazardous situation which if not avoided may result in serious injury or death.

The warning  indicates that damage resulting from failure to comply with the procedures and instructions is not covered by the warranty and the owner will be liable for any repair costs.

Safety indications are also given on the tool; they remind you of the safety precautions to be taken. Identify and read these indications before using the tool. Immediately replace any indications that may become partially illegible or deteriorated.

Refer to Section 2.4, "Safety signage" for the location diagram of the safety stickers affixed to the tool.

No part of this manual may be reproduced without the written permission of the company PELENC. The illustrations provided in this manual are for information purposes only and are in no way contractual. The PELENC company reserves the right to make any modification or improvement to its products as deemed necessary without informing customers already in possession of a similar model. This manual forms an integral part of the tool and must accompany the tool if it changes hands.

## 2. SAFETY



### Warning

Never carry out maintenance work on damaged battery packs. Service of battery packs should only be performed by the manufacturer or authorized service providers.

### 2.1. SAFETY MEASURES ASSOCIATED WITH THE USE OF THE TOOL

#### Note

Refer to the operating instructions for the tool concerned.



### Warning

Read all safety warnings and all instructions. Retain all the safety measures and instructions for later reference.

This device is not intended for use by individuals (including children) with reduced physical, sensory or mental capabilities, nor by anyone lacking in experience or knowledge, except if they are supervised or have received prior instructions from a person responsible for their safety.

### 2.2. SAFETY MEASURES ASSOCIATED WITH BATTERY USE

1. If not using the battery unit, store it away from other metal objects such as paper clips, coins, keys, nails, screws or other such small metal items that might form a connection between the two terminals. Creating a short-circuit between the battery terminals can lead to burns or cause a fire.
2. Keep the battery out of the reach of children and place it on a non-combustible support.
3. Do not interfere with its cooling cycle.
4. Do not use or leave the battery near a heat source (> 60°C).
5. Do not leave the battery in direct, strong sunlight.
6. Do not expose the battery to microwaves or high pressure.
7. Do not immerse the battery in water.
8. The batteries must be charged in a dry, ventilated room at a temperature between 10°C and 25°C maximum, away from any moisture.
9. If the battery is not used for 10 days, the battery will automatically discharge until it reaches its storage charge rate, then goes to standby. It will heat up during this phase.
10. Over time, the capacity of your battery decreases. When it reaches half of its original battery-life operating autonomy, it should be replaced.
11. The battery may lose 1 to 4 % of its capacity when exposed to a temperature higher than or equal to 55 °C for one week.
12. The charging location must be equipped with a class D fire extinguisher (for metal fires) in good working order.
13. The standards in effect must be complied with when shipping a complete tool or a battery.
  - Complete tool with battery: product classified UN3481 class 9.
  - Battery alone: product that is classified as class 9, UN3480.
14. Use of a battery other than that provided by Pellenc SA is dangerous (risk of serious injury). If a different battery is used, Pellenc SA cannot be held responsible for any consequences.
15. The battery must be protected from any impact and must be positioned and secured appropriately during transportation.
16. In the case of suspicious smoke, place the battery outside the charging area or transportation vehicle as far away as possible from any inflammable material.
17. Never store a battery when its capacity is below 50 %. Recharge the battery before storage if the value is below 50%.

18. In inappropriate conditions, a liquid can flow batteries; avoid contact with it. In the event of accidental contact, rinse with water. In the event of contact with eyes, seek professional medical help. The liquid leaking from the batteries can cause irritations or burns.
19. Pellenc power tools must only be used with the battery units designed for the purpose. Use of other battery units can present a risk of injury and fire.
20. Recharge only with the charger specified by the manufacturer. A charger adapted to one type of battery unit may present a fire risk if used with a different battery unit.
21. Do not use the battery for any purpose other than that initially envisaged (exclusively for use with Pellenc tools).
22. At the end of its life, the battery must be returned to the authorized distributor from whom it was purchased to be recycled in accordance with waste regulations.
23. Fragile case, contains an electronic board and lithium.

### 2.3. SAFETY MEASURES WHEN USING THE "PELENC" CHARGER

1. When in operation, the charger's temperature can reach 60°C. No flammable material must be within 1.5 metres of the charger and battery.
2. Place the charger out of the reach of children and on a non-combustible support.
3. Do not interfere with its cooling cycle.
4. The charger is intended only for recharging the battery. Do not charge non-rechargeable batteries.
5. The charging location must be equipped with a class D fire extinguisher (for metal fires) in good working order.
6. If the output cord is cut or damaged, bring the entire charger back to the authorised distributor where the tool was purchased.
7. Only recharge using the "PELENC" charger indicated by the manufacturer. A charger adapted to one type of battery unit may present a fire risk if used with a different battery unit.
8. This charger is designed to charge Pellenc tool lithium batteries.
9. Do not use it for any other purposes.
10. Children must be supervised to ensure they do not play with the charger.
11. Check that the cable cannot be bent and that it does not touch hot surfaces or sharp edges.
12. Ensure good ventilation during the charging.
13. Never cover the charger. This charger must not be used outdoors.
14. Make sure the power connector is not exposed to water.
15. Never attempt to charge a damaged battery.
16. The grid connection must comply with national electrical regulations.
17. Check the wiring of the charger before use. Never use the charger if the wiring is damaged.
18. When the battery is charging, place the charger on a non-flammable support, more than 1.5 m away from any flammable object.

**2.4. SAFETY SIGNAGE**

150 battery

**BATTERY Li-Ion**  
**REFERENCE 163689**  
**ULIB 150**

**43.2V x 3.45Ah = 150Wh**  
**IEC/EN 61960**  
**43.2V ≡ 3.30Ah**  
**12INR19/66**

**ICA·SA** TA - 2021 / 2504  
APPROVED

A utiliser uniquement avec le chargeur batterie PELLENC modèle } **CB5004HV2**  
For use only with PELLENC's battery charger model } **CB5010HV**  
Usar sólo con el cargador de batería PELLENC del modelo }  
  
Utiliser uniquement avec un chargeur PELLENC CB5010HV pour les USA et le Canada  
For use only with PELLENC CB5010HV for USA and Canada  
Utilizar sólo con el cargador PELLENC CB5010HV para EE.UU y Canadá

**Li-ion**

56\_21\_PICTO\_004



IP54 product protection rating (Protection against dust and water spray from all directions).

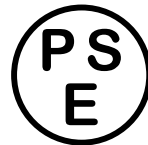

Non specified electrical products.



Please read the operating instructions.



Independent **C**ommunications **A**uthority of **S**outh **A**frica  
The product complies with the strict radio interference standards set by ICASA at the approved frequency.

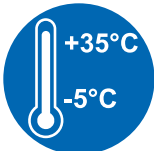

This equipment must be used at a temperature of between -5° and +35°C.



Marking symbol for identifying the chemical characteristic of the battery during recycling.



Tool compliant with British standards



Tool compliant with Moroccan standards.



**3. DESCRIPTION AND TECHNICAL CHARACTERISTICS**

**3.1. DESCRIPTION**

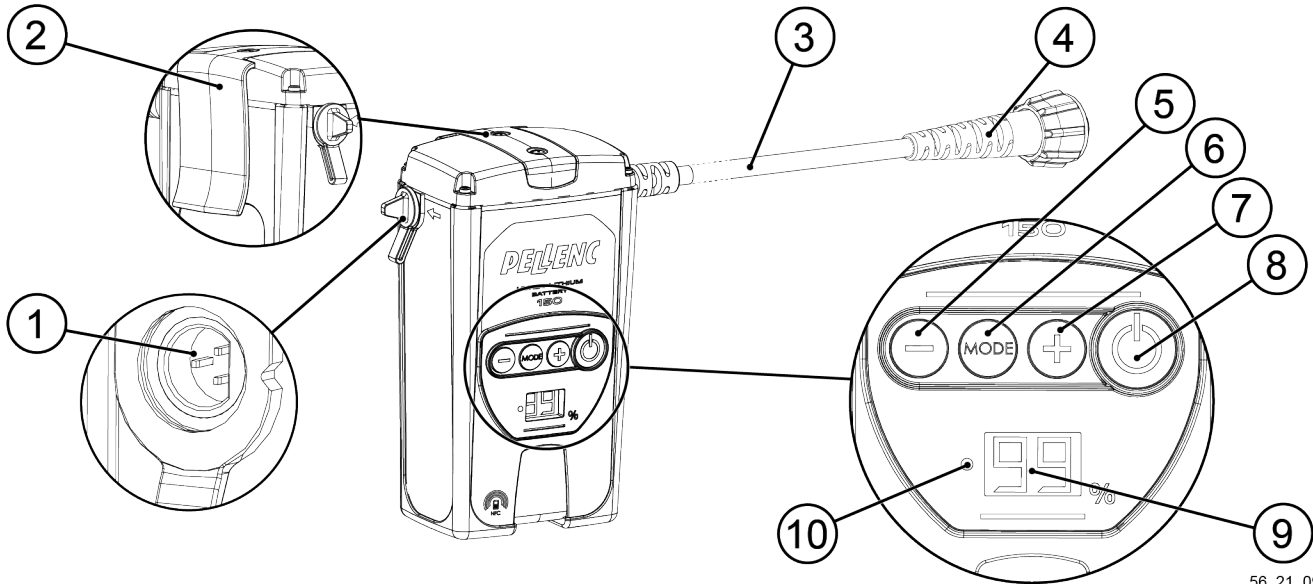

56\_21\_098

- 1. Charging connector
- 2. Battery clip to be clipped onto the adjustable belt
- 3. Tool power cord
- 4. Tool power cord connector
- 5. Decrease button
- 6. Mode switch button
- 7. Increase button
- 8. On/Off button
- 9. HMI display screen
- 10. Power on and charging LED

**3.2. BATTERY TECHNICAL FEATURES**

Name	Ulib 150
Rated battery voltage	43.2 V
Type of battery	12 cells in 1 pack
Battery capacity	3.45 Ah
Battery power	864 W
Battery energy	150 Wh
Operating frequency bands	3.56 MHz
Max. transmitted RF power	-41 dBm
Battery life	8 hours (with C35 pruning shears)
Weight of the battery unit	845 grams (without cord)

**3.3. TECHNICAL CHARACTERISTICS - CHARGER**

	Charger CB5004HV2	Charger CB5010HV
Charger reference	152271	132649
Voltage	100-240V ~50/60Hz Class II	
Charging voltage	50.2 V DC	
Charging current	0.4 A dc max.	1 A dc max.

Type of charger	150 battery charge percentage	150 battery charging time
Charger CB5004HV2 (0.4 A)	70%	6 h
	100%	9.5 hrs
Charger CB5010HV (1 A)	70%	2 hr 30 min
	100%	4 h 30 min

**Important**

The adapter, ref 152147, ensures compatibility between the CB5010HV charger and 150 battery.

## 4. COMMISSIONING

### 4.1. SWITCHING THE BATTERY ON AND OFF

#### Powering on

1. If the HMI display is off, press the Start/Stop button (1) to exit the battery from standby.

#### Note

The HMI display (2) shows the remaining battery capacity and the power LED (3) remains off when the unit is switched off.

2. Press the On/Off button (1).

#### Powering off

- Press the On/Off button (1).

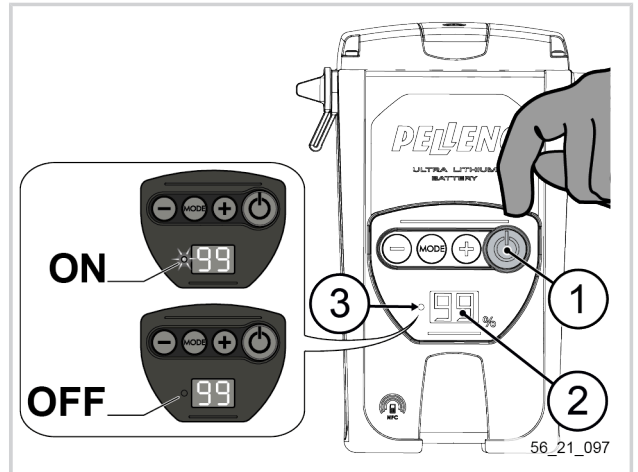

#### Note

The power-on LED (2) lights up when the power is turned on and goes out when the power is turned off.

### 4.2. HMI DISPLAY

The battery is equipped with an HMI display that shows the remaining capacity of the battery. The capacity is expressed as a percentage.

- The display shows 99%, the battery is fully charged.
- If the display shows > 55% after one day's work, it is not necessary to recharge the battery before a second similar day of work.
- The display shows 00% or a value very close to it, you must recharge immediately.

### 4.3. CHARGING

Before using the battery for the first time, it must be fully charged (99% steady).



#### Caution

Before connecting the charger to the mains, check that your power system characteristics comply with the specifications given on the charger (see Section 3.3, "Technical characteristics - Charger").

When the battery is discharged, the tool stops automatically. The gauge display goes off, and the buzzer beeps once. Then consult Section 7.1, "Recap of battery display messages and audible signals".

1. Make sure that the battery is switched off, see Section 4.1, "Switching the battery on and off".

2. Place the charger and battery in a dry, ventilated and dust-free room at 10#25°C. Place the battery lying in a horizontal position.
3. Connect the charger power connector (1) to the power outlet. The charger indicator (2) lights up red.

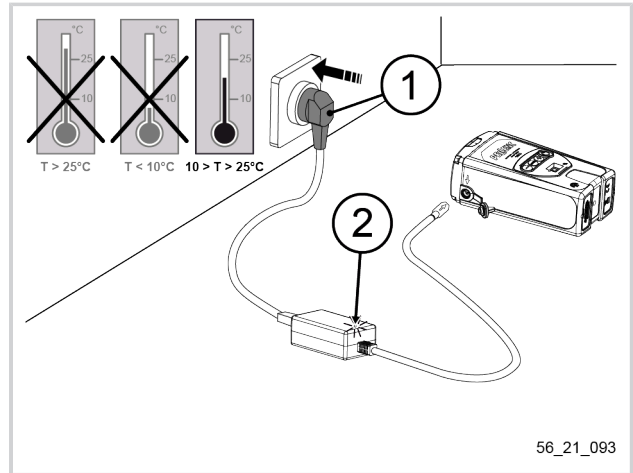

4. Align the arrows on the charging cord connector (3) with the charging connector (4) on the battery.
5. Connect the charging cable (3) to the charging connector (4) of the battery. The charger indicator (2) lights up green, and the battery indicator (5) flashes orange.

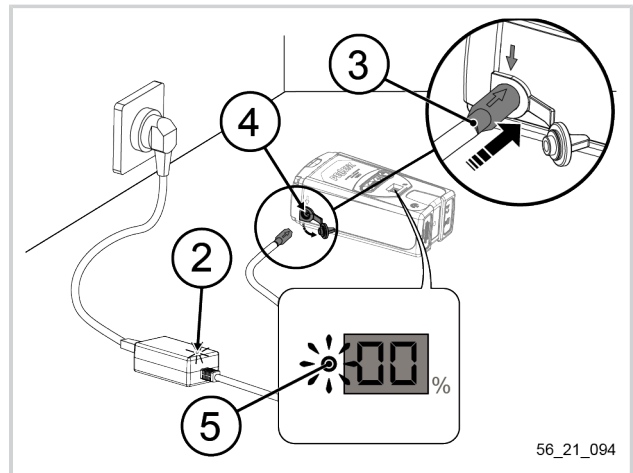

6. When the gauge display (6) flashes, the battery is charging. The charge is finished when the message 99 appears on the gauge display.

Once the battery is charged, first disconnect the charging cord (3) from the battery and then the mains plug from the charger (1).

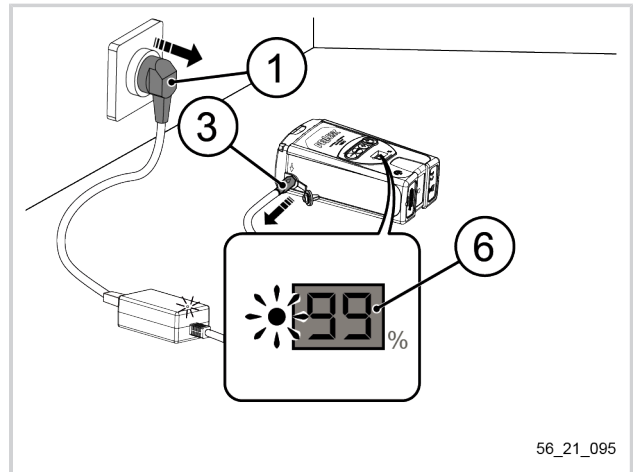

**Note**

After a long storage period (new battery, winter storage etc.), when you disconnect the charger, the charge level indicator may display a value of less than 99%. This is a normal phenomenon which can reoccur for up to 5 charge cycles with normal use between each charge.

**4.4. FITTING THE HOLSTER TO THE BELT**

1. Detach the hook and loop strap (1).
2. Pull the hook and loop strap (1) out of the belt loop (2).
3. Install the holster (3) on the belt (4).

**Note**

When fitting the holster on the right, ensure that the hook and loop strap is on your right.

When fitting the holster on the left, ensure that the hook and loop strap is on your left.

4. Position the hook and loop strap (1) on the holster (3).
5. Slide the end of the hook and loop strap (1) into the belt loop (2).
6. Pull and fasten the hook and loop strap (1).
7. Position the belt at waist level and adjust the tightness with the tabs (5).

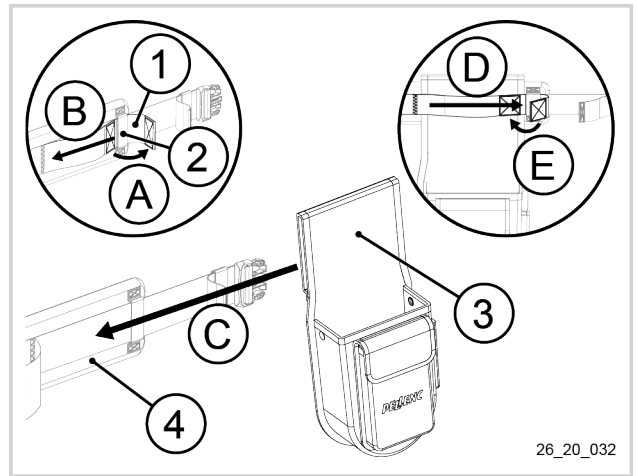

26\_20\_032

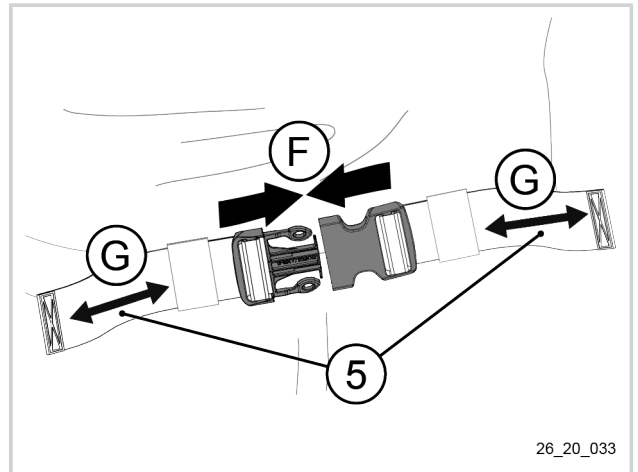

26\_20\_033

8. Clip the battery (6) onto the belt (4) and connect the tool power cord (7) to the tool, see Section 4.5, "Tool connection".
9. Put the tool in the holster (3).
10. Attach the tool power cord (7) to the arm using the armband provided, see Section 4.6, "Putting the lead and wrist strap in place".

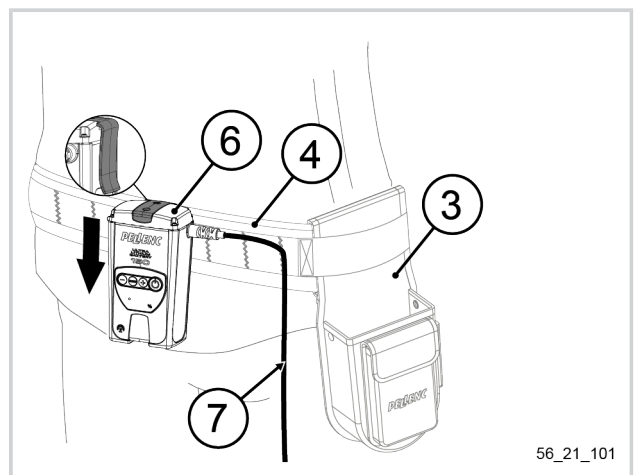

56\_21\_101

**4.5. TOOL CONNECTION**

**Note**

For more information on connecting the tool to the battery, refer to the tool's operating instructions manual.

**4.6. PUTTING THE LEAD AND WRIST STRAP IN PLACE**

1. Put on the belt then clip the battery to it and install the connected tool in the holster, see Section 4.4, "Fitting the holster to the belt" and Section 4.5, "Tool connection".
2. Put the armband (1) around your arm.

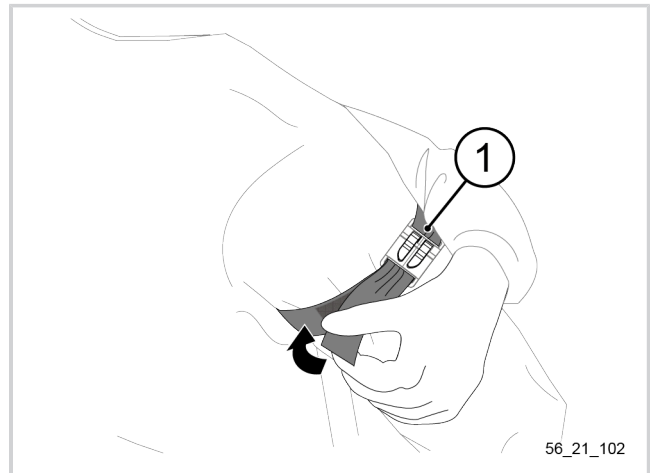

3. Insert the tool power cord (2):
  - in parallel if it is to slide into the armband clip (3);
  - perpendicularly if it is to be attached in the armband clip (3).

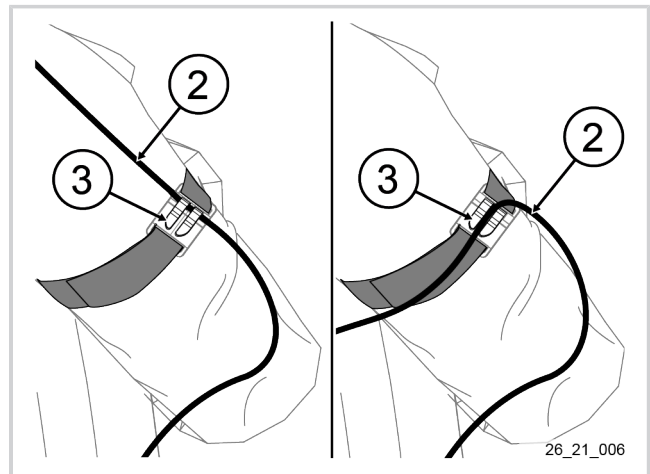

## 5. USING THE TOOL

### Note

For more information on the modes of use and "functional" settings, please refer to the tool operating instructions.

### 5.1. AUTHORISATION MODES

#### 5.1.1. CHANGE OF AUTHORISATION MODE

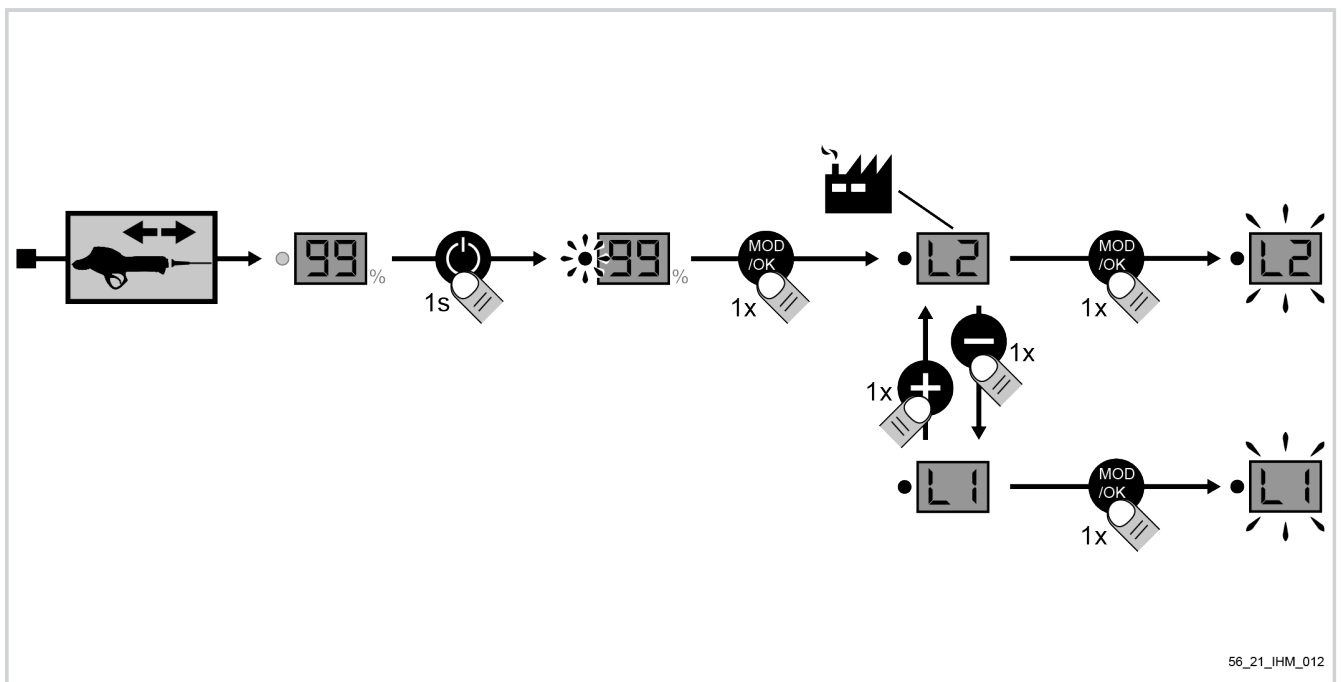

56\_21\_IHM\_012

1. Disconnect the tool and turn on the battery,
2. Press the "mode" button,
3. Select the mode by pressing + or -,
4. Press the "mode" button to confirm,
5. After setting the mode, turn off the battery and then reconnect the tool.

#### 5.1.2. PRESENTATION OF AUTHORISATION MODES

You can set the parameters for the tool's adjustment level to make it easier to use.

- L1: "Normal" mode: the user has access to the operating modes but no "functional" adjustments are possible.
- L2: "Expert" mode: the user accesses the operating modes and "functional" settings. 

**6. MAINTENANCE**

**6.1. MAINTENANCE TABLE**

Maintenance task	At each start-up	Every 4 hours	Every week	After each use	Every year or as necessary
Visual inspection of the general condition of the battery (no deformation or wear)				X	
Visual inspection of the general condition of the charger (no deformation or wear)				X	
Check of the tightness of the tool power cord knob	X				
Check the battery level.	X				
Cleaning the battery, see Section 6.2, "Cleaning the battery".				X	
Cleaning the battery, see Section 6.3, "Cleaning the charger".				X	
Battery check by an authorised dealer PELENC.					X

**Important**

Have the battery serviced every 400 hours or at least once a year by an authorised dealer PELENC. Always store the charged and clean battery in a dry place.

**6.2. CLEANING THE BATTERY**

1. Make sure that the battery is switched off, see Section 4.1, "Switching the battery on and off".
2. Ensure that the battery is disconnected from the charger and the tool.
3. Clean the battery casing with a soft damp cloth.

**Important**

Cleaning shall be carried out with water only and without detergent, chlorine or sterilising solutions with an alkaline reaction.

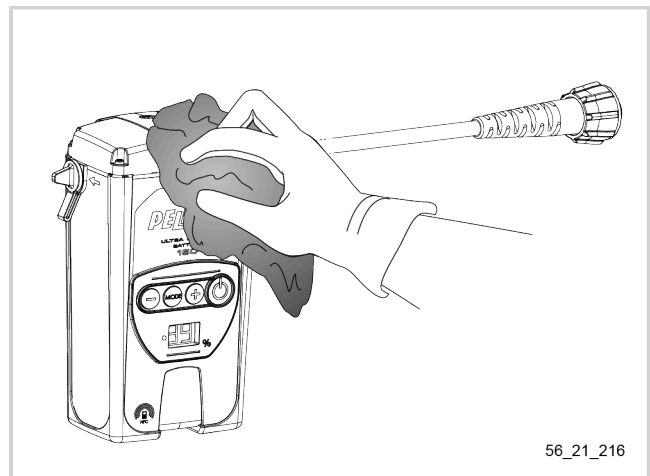

56\_21\_216

**6.3. CLEANING THE CHARGER**

1. Ensure that the charger is unplugged and disconnected from the battery.
2. Clean the charger housing with a soft damp cloth.





























**Important**

Cleaning shall be carried out with water only and without detergent, chlorine or sterilising solutions with an alkaline reaction.













**7. INCIDENTS AND TROUBLESHOOTING**

**7.1. RECAP OF BATTERY DISPLAY MESSAGES AND AUDIBLE SIGNALS**

Normal messages	
Use	
 fixed	Battery charge level (0 to 99)
 with 1 beep per minute	Battery empty, recharge immediately
 flashing with 1 beep every 10 seconds	Stop using, recharge immediately. <b>Only on ALPHA batteries connected to an ALPHA Tool.</b>
 Flashing	Display off to avoid duplication with tool display
Charging	
 flashing every 4 seconds	Battery charge level (0 to 99)
 fixed	Charging complete
Storage	
Off	Standby
Degraded mode messages	
Use	
 and  alternately	Stop the tool; the battery temperature is too high
 and  and  alternately	Stop the tool; the battery temperature is too low
 	Electronic board out of order
 	Electronic board not configured
 fixed	Cell voltage too low
Long beep and 1 short beep	Tool stop: tool intensity too high
Long beep and 2 short beeps	Incompatible tool detected
Long beep and 4 short beeps	Stop the tool; the tool temperature is too high
Charging	
 and  alternately	Charge interrupted: Battery temperature too low
 and  alternately	Charge interrupted: Battery temperature too high
Fault messages	
Use	
 and 1 beep every 2 minutes for 24 hours	Voltage too low after 3 hours of non-use. Recharge battery immediately
	Electronic board out of order
	Short circuit on the tool connector
Long beep and 5 short beeps	Loss of connection, tool not detected

Fault messages	
Charging	
 and  alternating and continuous beep	Battery problem
 and  alternately	Charger problem

**7.2. TROUBLESHOOTING**

Symptoms	Battery display messages and beeps	Probable cause	Checks	Solutions	Repairer		
The battery does not start	 with 1 beep per minute	Empty battery	Check that the battery is not completely discharged	Recharge the battery	User		
		Electronic circuit board	At an authorised PELENC distributor	Configuring the electronic board	Authorised PELENC distributor		
							
The tool stops during use		The tool has reached its temperature limit	4 beeps from the battery	Let the tool cool down for roughly 5 minutes	User		
	Long beep and 4 short beeps						
	 and  alternately					Battery temperature too high	Let the battery cool down for about 5 minutes
The battery does not charge	 and  alternately	Battery temperature	Battery temperature too low	Use the battery within the correct temperature range	User		
	 and  alternately					Battery temperature too low	Use the battery within the correct temperature range
	 and  alternately					Battery temperature too high	Let the battery cool down for about 5 minutes

**Caution**

Never attempt to open or repair the battery pack or the charger.

**7.3. BATTERY REPLACEMENT****Important**

The battery must only be replaced and disposed of by an authorised distributor.

## 8. STORAGE AND TRANSPORT

### 8.1. BATTERY STORAGE CONDITIONS

- Store the “battery” unit and charger away from heat, dust and humidity, after turning off the battery using one of the on/off. buttons. Never store the battery in an ambient temperature of more than +45 °C.
- In order to conserve a long battery life and prevent deterioration, the battery must be charged when stored and recharged every 24 months if it is not used.
- Never operate the push-buttons during the storage period.
- To ensure long battery life, the battery should be stored in a dry and warm place between 0 °C and 25 °C.
- No combustible object must be placed within 1.5 metres of the battery.
- The charger is maintenance-free.
- If the battery is not used for 10 days, the battery is automatically discharged to a storage state to preserve its life, and heating of the battery may occur during this phase.

## 9. ACCESSORIES AND CONSUMABLES

### 9.1. OPTIONAL ACCESSORIES

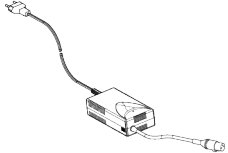
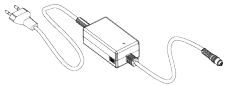
Name	Reference	
Charger adapter 1A	152147	 32_20_196
Charger CB5010HV (1A)	132649	 56_21_236
Charger CB5004HV2 (0.4 A)	152271	 56_21_237

**9.2. CONSUMABLES**

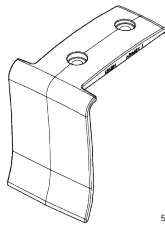
Name	Reference	
Battery clip to be clipped onto the adjustable belt	131391	 56_21_231

## 10. WARRANTIES

### 10.1. GENERAL WARRANTIES

#### 10.1.1. STATUTORY WARRANTY

##### 10.1.1.1. LATENT DEFECTS WARRANTY

Apart from the commercial warranty provided for under Article II, Article 1641 of the Civil Code provides that "the seller is bound to a warranty on account of latent defects of the object sold which render it unfit for the use for which it was intended, or which would impair said use to the extent that the buyer would not have acquired it, or would only have given a lesser price for it, had he known of them".

Article 1648 of the Civil Code "The action resulting from latent defects must be brought by the purchaser within two years after the discovery of the defect."

##### 10.1.1.2. LEGAL WARRANTY OF CONFORMITY

Article L.217-4 of the French Consumer Code "The seller delivers goods in conformity with the contract and is liable for defects of conformity existing upon delivery".

The seller is also liable for any lack of compliance resulting from the packaging, assembly or installation instructions whenever its contractual liability is engaged in this regard or the latter are carried out under its responsibility.

Article L.217-5 of the French Consumer Code "Goods are compliant with the contract":

1. Where they are fit for the purpose normally expected of similar goods and, where applicable:
  - If it matches the description given by the seller and possesses the qualities that were presented to the purchaser in the form of a sample or model;
  - If it possesses the qualities that a purchaser can reasonably expect given the public statements made by the seller, the producer or its representative, especially in advertising or labelling;
2. Or, if it has the characteristics defined by mutual agreement of the parties or is fit for any particular purpose that the buyer made known to the seller and that the latter accepted.

Article L.217-12 of the Consumer Code "legal action resulting from lack of conformity lapses two years after delivery of the goods".

#### 10.1.2. COMMERCIAL WARRANTY PELENC

##### 10.1.2.1. CONTENT

###### 10.1.2.1.1. GENERAL INFORMATION

In addition to legal warranties, client users benefit from the commercial warranty on products PELENC covering the exchange and replacement of parts recognised as being out of order, due to machining defects, assembly defects or material defects, whatever the cause.

The warranty is fully integral to the product sold by PELENC.

###### 10.1.2.1.2. SPARE PARTS

The commercial warranty also covers original PELENC spare parts, excluding labour and to the exclusion of certain parts of each product provided at delivery.

**10.1.2.2. DURATION OF THE WARRANTY****10.1.2.2.1. GENERAL INFORMATION**

PELLENC Products are guaranteed under the commercial warranty as from delivery to the customer for a period of two (2) years for products connected to a PELLENC battery, and for a period of one (1) year for other PELLENC products.

**10.1.2.2.2. SPARE PARTS**

PELLENC Replacement parts replaced under the product warranty are guaranteed under the commercial warranty as from delivery of the PELLENC product to the customer user for a period of two (2) years for products connected to a PELLENC battery, and for a period of one (1) year for other PELLENC products.

In the case of products connected to a PELLENC battery, parts that are replaced under the product warranty after the 12th month of use, are covered for a period of one (1) year.

**10.1.2.2.3. WARRANTY EXCLUSIONS**

Excluded from the commercial warranty are products that have been subject to abnormal use, or were used under conditions and for purposes other than those for which they were manufactured, especially in the case of non-compliance with conditions stipulated in this operating instructions manual.

It does not apply in case of shock, fall, neglect, lack of supervision or maintenance or in case of transformation of the product. Also excluded from the warranty are products that have been subject to tampering, alteration or modification by the customer user.

Wear parts and/or consumables cannot be covered by the warranty.

**10.1.2.3. IMPLEMENTATION OF THE COMMERCIAL WARRANTY****10.1.2.3.1. PRODUCT COMMISSIONING AND COMMISSIONING DECLARATION**

The DISTRIBUTOR undertakes to complete the computer commissioning declaration form, no later than eight days after the delivery of the property to the user customer, in order to activate the latter on the [www.pellenc.com](http://www.pellenc.com) website under "warranties and training" in the "extranet" menu, using the identifier previously provided to them by PELLENC.

Failing that, commissioning declaration will not be effective and implementation of the commercial warranty PELLENC will not occur. As a consequence thereof, the DISTRIBUTOR must ensure the financial burden of its intervention under the warranty without being able to pass on the cost to the client user.

The DISTRIBUTOR shall also undertake to complete the warranty card or the certificate of warranty and commissioning for self-propelled equipment provided with the product after having the client user sign and date it.

**10.1.3. PAID AFTER-SALES SERVICE****10.1.3.1. GENERAL INFORMATION**

Malfunctions, breakdowns, breakages resulting from misuse, neglect or improper maintenance by the client user as well as malfunctions resulting from normal wear of the product are subject to the payment of after-sales service, even during the period of the legal and commercial warranty. After-sales service repairs that fall outside of the legal and commercial warranty also include maintenance, adjustments, diagnostics of all types, and cleaning without the present list being exhaustive.



**10.1.3.2. WEAR PARTS AND CONSUMABLES**

Wear parts and consumables also fall within the after-sales service.

**10.1.3.3. SPARE PARTS**

Paid after-sales service also covers original PELENC spare parts, excluding labour and outside the legal and commercial warranty period.

In case of replacement of original PELENC spare parts in the context of after-sales service, said latter are covered by a warranty of one year as from the installation date.

**11. COMPLIANCE STATEMENTS**

**11.1. "EU" DECLARATION OF CONFORMITY: 150 BATTERY**

MANUFACTURER/ENTITY AUTHORISED TO COMPILE THE TECHNICAL FILE	PELENC
ADDRESS	Quartier Notre-Dame - 84120 Pertuis (France)

We hereby declare that the product designated below as:

GENERIC DENOMINATION	BATTERY		
FUNCTION	Intended to power PELENC portable power tools		
COMMERCIAL NAME	ULTRA LITHIUM BATTERY		
TYPE	Li-ion battery		
MODEL	150		
SERIAL No.	26V00001 - 26V49999	26W00001 - 26W49999	26X00001 - 26X49999
	56V00001 - 56V49999	56W00001 - 56W49999	56X00001 - 56X49999

Complies with all the relevant provisions of the EMC Directive 2014/30/EU.

Complies with the provisions of the following European Directives:

- 2006/66 / EC Battery waste directive; 2011/65 / EU ROHS Directive; 1907/2006 REACH regulation; 2014/53 / EU RED Directive

The following harmonised European standards have been used in part or in full:

- EN 62133-2 : 2017 ; EN 60529 :1991+ A2 :2013 + AC :2019

SIGNED IN PERTUIS, DATED 15/10/2021

JEAN-MARC GIALIS

CHIEF EXECUTIVE OFFICER



**11.2. UK DECLARATION OF CONFORMITY <sup>UK</sup>CA : BATTERIE 150**

MANUFACTURER / ENTITY AUTHORIZED TO COMPILE THE TECHNICAL FILE	PELENC
ADDRESS	Quartier Notre-Dame - 84120 Pertuis (France)

We hereby declare that the product referred to below as:

GENERIC DENOMINATION	BATTERY		
FUNCTION	Intended to power PELENC portable power tools		
COMMERCIAL NAME	ULTRA LITHIUM BATTERY		
TYPE	Li-ion battery		
MODEL	150		
SERIAL No.	26V00001 - 26V49999	26W00001 - 26W49999	26X00001 - 26X49999
	56V00001 - 56V49999	56W00001 - 56W49999	56X00001 - 56X49999

Complies with the relevant provisions of the Electromagnetic Compatibility Regulations 2016.

Complies with the following other directives and / or relevant provisions :

- Restriction of the Use of Certain Hazardous Substances in Electrical and Electronic Equipment Regulations 2012 ; 1907/2006 REACH Regulation ; Radio Equipment Regulations 2017 ; Directive 2006/66/EC

The following harmonized european standards were used:

- BS EN 62133-2 : 2017 ; BS EN 60529 : 1992 + A2 : 2013

SIGNED IN PERTUIS, DATED 15/10/2021

JEAN-MARC GIALIS

CEO



**11.3. "EU" DECLARATION OF CONFORMITY: CHARGER CB5010HV**

MANUFACTURER/ENTITY AUTHORISED TO COMPILE THE TECHNICAL FILE	PELLENC
ADDRESS	Quartier Notre-Dame - 84120 Pertuis (France)

We hereby declare that the product designated below as:

GENERIC DENOMINATION	BATTERY CHARGER		
FUNCTION	Designed to charge Pellenc tool batteries		
COMMERCIAL NAME	CB		
TYPE	1 A		
MODEL	CB5010HV		
SERIAL No.	32V00001 - 32V49999	32W00001 - 32W49999	32X00001 - 32X49999
	56V00001 - 56V49999	56W00001 - 56W49999	56X00001 - 56X49999

Complies with the relevant provisions of the low voltage directive 2014/35/EC.

Complies with the provisions of the following European Directives:

- 2014/30/EU EMC Directive; 2011/65/EU ROHS Directive; 1907/2006 REACH Regulation; 2012/19/EU WEEE Directive

The following harmonised European standards have been used in part or in full:

- EN 60335-1:2012 / A11:2014 ; EN 60335-2-29:2004/A2:2010 ; EN 62233:2008 ; EN 55014-1:2006 / A2:2011 ; EN 55014-2:1997 / A2:2008 ; EN 61000-3-2:2014 ; EN 61000-3-3:2013

SIGNED IN PERTUIS, DATED 28/09/2021

JEAN-MARC GIALIS

CHIEF EXECUTIVE OFFICER



**11.4. UK DECLARATION OF CONFORMITY <sup>UK</sup>CA : CB5010HV CHARGER**

MANUFACTURER / ENTITY AUTHORIZED TO COMPILE THE TECHNICAL FILE	PELENC
ADDRESS	Quartier Notre-Dame - 84120 Pertuis (France)

We hereby declare that the product referred to below as:

GENERIC DENOMINATION	BATTERY CHARGER		
FUNCTION	Designed to charge Pellenc batteries		
COMMERCIAL NAME	CB		
TYPE	1 A		
MODEL	CB5010HV		
SERIAL No.	32V00001 - 32V49999	32W00001 - 32W49999	32X00001 - 32X49999
	56V00001 - 56V49999	56W00001 - 56W49999	56X00001 - 56X49999

Complies with the relevant provisions of the Electrical Equipment (Safety) Regulations 2016.

Complies with the following other directives and / or relevant provisions :

- Electromagnetic Compatibility Regulations 2016 ; Restriction of the Use of Certain Hazardous Substances in Electrical and Electronic ; Equipment Regulations 2012 ; 1907/2006 REACH Regulation ; Radio Equipment Regulations 2017

The following harmonized european standards were used:

- BS EN 60335-1:2012 + A11:2014 ; BS EN 60335-2-29:2004+A2:2010 ; BS EN 62233:2008 ; BS EN 55014-1:2006+A2:2011 ; BS EN 55014-2:1997 / A2:2008 ; BS EN 61000-3-2:2014 ; BS EN 61000-3-3:2013

SIGNED IN PERTUIS, DATED 28/09/2021

JEAN-MARC GIALIS

CEO



**11.5. "EU" DECLARATION OF CONFORMITY: CHARGER CB5004HV2**

MANUFACTURER/ENTITY AUTHORISED TO COMPILE THE TECHNICAL FILE	PELLENC
ADDRESS	Quartier Notre-Dame - 84120 Pertuis (France)

We hereby declare that the machine referred to below as:

GENERIC DENOMINATION	BATTERY CHARGER		
FUNCTION	Designed to charge Pellenc tool batteries		
COMMERCIAL NAME	CB		
TYPE	0.4 A		
MODEL	CB5004HV2		
SERIAL No.	26V00001 - 26V49999	26W00001 - 26W49999	26X00001 - 26X49999
	32V00001 - 32V49999	32W00001 - 32W49999	32X00001 - 32X49999
	56V00001 - 56V49999	56W00001 - 56W49999	56X00001 - 56X49999

Complies with the relevant provisions of the low voltage directive 2014/35/EC.

Complies with the provisions of the following European Directives:

- 2014/30/EU EMC Directive; 2011/65/EU ROHS Directive; 1907/2006 REACH Regulation; 2012/19/EU WEEE Directive

The following harmonised European standards have been used in part or in full:

- EN 60335-1:2012 / A13:2017 ; EN 60335-2-29:2004/A11:2018 ; EN 62233:2008 ; EN 55014-1:2017 ; EN 55014-2:2015 ; EN 61000-3-2:2019 ; EN 61000-3-3:2013/A1:2019

SIGNED IN PERTUIS, DATED 15/10/2021

JEAN-MARC GIALIS

CHIEF EXECUTIVE OFFICER



**11.6. UK DECLARATION OF CONFORMITY <sup>UK</sup>CA : CHARGEUR CB5004HV/5004HV2**

MANUFACTURER / ENTITY AUTHORIZED TO COMPILE THE TECHNICAL FILE	PELENC
ADDRESS	Quartier Notre-Dame - 84120 Pertuis (France)

We hereby declare that the product referred to below as:

GENERIC DENOMINATION	BATTERY CHARGER		
FUNCTION	Designed to charge Pellenc batteries		
COMMERCIAL NAME	CB		
TYPE	0,4 A		
MODEL	CB5004HV / 5004HV2		
SERIAL No.	26U00001 - 32U49999	26V00001 - 32V49999	26W00001 - 32W49999
	32U00001 - 32U49999	32V00001 - 32V49999	32W00001 - 32W49999
	56U00001 - 56U49999	56V00001 - 56V49999	56W00001 - 56W49999

Complies with the relevant provisions of the Electrical Equipment (Safety) Regulations 2016.

Complies with the following other directives and / or relevant provisions :

- Electromagnetic Compatibility Regulations 2016 ; Restriction of the Use of Certain Hazardous Substances in Electrical and Electronic ; Equipment Regulations 2012 ; 1907/2006 REACH Regulation ; Radio Equipment Regulations 2017

The following harmonized european standards were used:

- BS EN 60335-1:2012 + A11:2014 ; BS EN 60335-2-29:2004+A2:2010 ; BS EN 62233:2008 ; BS EN 55014-1:2017 ; BS EN 55014-2:2015 ; BS EN 61000-3-2:2014 ; BS EN 61000-3-3:2013

SIGNED IN PERTUIS, DATED 10/03/2021

JEAN-MARC GIALIS

CEO













# **PELLENC**

   [www.pellenc.com](http://www.pellenc.com)

PELLENC  
Quartier Notre Dame - 84120 Pertuis (France)

